



UL International (Netherlands) B.V.
Westervoortsedijk 60,
6827AT Arnhem,
The Netherlands



designated according to Article 29 of the Regulation (EU) No 305/2011 and member of EOTA (European Organisation for Technical Assessment, www.eota.eu)

European Technical Assessment

ETA 23/0054
of 28/11/2023

Technical Assessment Body issuing the ETA and designated according to Article 29 of the Regulation (EU) No 305/2011: **UL International (Netherlands) B.V.**

Trade name of the construction product

Mulcol® Multiwrap

Product family to which the construction product belongs

Fire Stopping and Sealing Product:
• Penetration Seals

Manufacturer

Mulcol International BV
PO Box 93
4330 AB Middelburg
The Netherlands

Manufacturing plant(s)

E/006

This European Technical Assessment contains

88 pages including 3 Annexes which form an integral part of this assessment.

This European Technical Assessment is issued in accordance with regulation (EU) No 305/2011, on the basis of

EAD 350454-00-1104

Translations of this European Technical Assessment in other languages shall fully correspond to the original issued document and should be identified as such.

Communication of this European Technical Assessment, including transmission by electronic means, shall be in full. However, partial reproduction may be made, with the written consent of the issuing Technical Assessment Body. Any partial reproduction has to be identified as such.

I.	SPECIFIC PARTS OF THE EUROPEAN TECHNICAL ASSESMENT	3
1.	Technical description of the product	3
2.	Specification of the intended uses of the product in accordance with the applicable European Assessment Document (hereinafter EAD): EAD 350454-00-1104	3
3.	Performance of the product and references to the methods used for its assessment	5
4.	Assessment and Verification of Constancy of Performance (hereinafter AVCP) applied, with reference to its legal base	6
5.	Technical details necessary for the implementation of the AVCP system, as provided for in the applicable EAD	6
	Annex A - Flexible and rigid walls	8
	Annex B - Rigid floors	38
	Annex C - General	63

I. SPECIFIC PARTS OF THE EUROPEAN TECHNICAL ASSESSMENT

1. Technical description of the product

- 1) Mulcol® Multiwrap is a closure device used to reinstate the fire resistance performance of wall and floor constructions where they have been provided with apertures for the penetration of single or multiple services.
- 2) Mulcol® Multiwrap is supplied in single layer rolls in boxes. The wrap is wrapped around the service or services and pushed into the aperture in the separating element / Mulcol® Multimastic C system / Mulcol® Multiwrap system.
- 3) The products below can be used in conjunction with Mulcol® Multiwrap depending upon the required application and classification (see Annex A/B). These products are subject to separate ETAs.
 - Mulcol® Multimastic FB, Firestop board
 - Mulcol® Multiwrap, Firestop mortar
 - Mulcol® Multisealant SP, Firestop mastic
- 4) The applicant has submitted a written declaration that Mulcol® Multiwrap does not contain substances which have to be classified as dangerous according to Directive 67/548/EEC and Regulation (EC) No 1272/2008 and listed in the "Indicative list on dangerous substances" of the EGDS - taking into account the installation conditions of the construction product and the release scenarios resulting from there.

In addition to the specific clauses relating to dangerous substances contained in this European technical Assessment, there may be other requirements applicable to the products falling within its scope (e.g. transposed European legislation and national laws, regulations and administrative provisions). In order to meet the provisions of the Construction Products Regulation, these requirements need also to be complied with, when and where they apply.

2. Specification of the intended uses of the product in accordance with the applicable European Assessment Document (hereinafter EAD): EAD 350454-00-1104

Detailed information and data is given in Annex A, B and C.

- 1) The intended use of Mulcol® Multiwrap is to reinstate the fire resistance performance of flexible wall, rigid wall and floor constructions where they are penetrated by various services.
- 2) The specific elements of construction that the system Mulcol® Multiwrap may be used to provide a penetration seal in, are as follows:
 - a) Flexible walls*: The wall must have a minimum thickness of 100 mm.
 - b) Rigid walls*: The wall must have a minimum thickness of 100 mm and comprise concrete, aerated concrete or masonry, with a minimum density of 400 kg/m³.
 - c) Rigid floors: The floor must have a minimum thickness of 150 mm and comprise aerated concrete or concrete with a minimum density of 400 kg/m³.

* See Annex C for the field of application.

The supporting construction must be classified in accordance with EN 13501-2 for the required fire resistance period.
- 3) The system Mulcol® Multiwrap may be used to provide a penetration seal with services e.g. cables, cable trays, metal pipes, composite pipes and plastic pipes, with and without insulation, with mixed services within the same seal/aperture (for details see Annex A and B).
- 4) The Mulcol® Multiwrap may be used to seal apertures in separating elements up to a maximum seal size given in Annex C. The minimum permitted separation between adjacent seals/apertures is 100 mm when penetration seals are ≤ 300 x 300 mm, a separation of 200 mm for larger seals.
- 5) The provisions made in this European Technical Assessment are based on an assumed working life of 25 years, provided that the conditions laid down in the product datasheet for the packaging/ transport/ storage/ installation/ use/ repair are met. The indications given on the working life cannot be interpreted as a guarantee given by the producer, but are to be regarded only as a means for choosing the right products in relation to the expected economically reasonable working life of the works.
- 6) Type Y₁: product intended for use at conditions exposed to free weathering.
- 7) Mutual distances between services and minimum support distances are given in Annex C.
- 8) If the solution is in combination with the Mulcol® Multiwrap, a maximum of 5 mm protrusion from the surface of the separating element or penetration seal is allowed.

9) Insulation types

The following acoustic insulation types are allowed (or equal):

- ABSound Sonocool
- Jacomassa / Sonimass
- Merfisol Silver Alu
- ThermaCompact TF

The following elastomeric insulation types are given in Annex A and B (or equal, not limited by brand or type):

- Reaction to fire class \leq B-s1, d0 – e.g. ArmaFlex Ultima, Kaiflex KK Plus S1
- Reaction to fire class \leq B-s2, d0 – e.g. ArmaFlex AF EVO, Kaiflex KK Plus S2 / ST, K-Flex ST
- Reaction to fire class \leq B-s3, d0 – e.g. ArmaFlex AF / XG / SH, K-Flex H
- Reaction to fire class \leq C-s2, d0 – e.g. Kaiflex HT S2
- Reaction to fire class \leq D-s3, d0 – e.g. ArmaFlex NH / SH / HT

The insulations may also have a B_L , C_L or D_L classification (linear insulation).

10) Pipes types

The following multi layered pipes (or equal) are allowed:

- Alpex DUO, Valsir Pexal, Valsir Mixal and APE Plain (PE-Xb/AL/PE-Xb)
- Uponor and Geberit Mepla (PE-RT/AL/PE-RT)
- Uponor and Henco (PE-Xc/AL/PE-Xc)
- Uponor and REHAU (PE-Xa) and REHAU (PE-Xc)
- SP Superpipe and POLYGON PEX (PE-X/AL/PE-X)
- Valsir Pexal and Valsir Mixal (PE/AL/PE-Xb)
- Wavin Tigris, Protecta-Line System and Alpex F50 Profi (PE-X/AL/PE)

The following fibre composite pipes (or equal) are allowed:

- Aquatechnik Fusio PP-R 80, Aquatechnik Fusio PP-RCT
- Aquatherm Blue-MF, Aquatherm Blue-S, Aquatherm Red-MF, Aquatherm Green-MF, Aquatherm Green-MS, Aquatherm Green-S, Aquatherm Lilac-S, Aquatherm Grey-MS and Aquatherm Orange M
- Bänninger PP-R, Bänninger Climatic PP-RCT and Bänninger Watertec PP-RCT

The following low-noise (silent) pipes (or equal) are allowed:

- Coes PhoNoFire and Coestilen BluePower
- Geberit Silent PP and Geberit Silent dB 20
- Girpi Friaphon and Marley Silent
- Pipelife Master 3 and PhonEX AS
- Poloplast POLO-KAL NG and Poloplast POLO-KAL 3S
- Skolan dB
- Raupiano Plus
- Valsir Triplus, Wavin SiTech+ and Wavin AS
- DykaSono
- Uponor Decibel

3. Performance of the product and references to the methods used for its assessment

Product-type: Coated Board		Intended use: Penetration Seal
Assesment method	Essential characteristic	Product Performance
<u>BWR 2 Safety in case of fire</u>		
EN 13501-1	Reaction to fire	C-s1, d0
EN 13501-2	Resistance to fire	Annex A, B & C
<u>BWR 3 Hygiene, health and enviroment</u>		
EN 1026	Air permeability	No performance determined
EAD 350454-00-1104, Annex C	Water permeability	No performance determined
Declaration of manufacturer & EN 16516	Release of dangerous substances	IA1, S/W 1 - Declaration of manufacturer
<u>BWR 4 Safety in use</u>		
EOTA TR 001:2003	Mechanical resistance and stability	No performance determined
EOTA TR 001:2003	Resistance to impact/movement	No performance determined
EOTA TR 001:2003	Adhesion	No performance determined
EAD 350454-00-1104, Clause 2.2.9	Durability	Y ₁
<u>BWR 5 Protection against noise</u>		
EN 10140-1,2,4,5 / EN ISO 7171-1	Airborne sound insulation	No performance determined
<u>BWR 6 Energy economy and theat retention</u>		
EN 12664, EN 12667, EN 12939, EN ISO 8990, EN ISO 6946, EN ISO 14683, EN ISO 10211, EN ISO 10456	Thermal properties	No performance determined
EN ISO 12572, EN 12086, EN ISO 10456	Water vapour permeability	No performance determined

4. Assessment and Verification of Constancy of Performance (hereinafter AVCP) applied, with reference to its legal base

According to the decision 1999/454/EC – Commission Decision of date 22nd June 1999 on the procedure for attesting the conformity of construction products pursuant to Article 20(2) of Council Directive 89/106/EEC as regards to fire stopping, fire sealing and fire protective products, published in the Official Journal of the European Union (OJEU) L178/52 of 14/07/1999, see <http://eur-lex.europa.eu/JOIndex.do> of the European Commission¹, as amended, the system(s) of assessment and verification of constancy of performance (see Annex V to Regulation (EU) No 305/2011) given in the following table(s) applies (apply).

Product(s)	Intended use(s)	Level(s) or class(es)	System(s)
Fire stopping and Fire Sealing Products	For fire compartmentation and/or fire protection or fire performance	Any	1

5. Technical details necessary for the implementation of the AVCP system, as provided for in the applicable EAD

Tasks of the manufacturer:

Factory production control

The manufacturer shall exercise permanent internal control of production. All the elements, requirements and provisions adopted by the manufacturer shall be documented in a systematic manner in the form of written policies and procedures, including records of results performed. This production control system shall ensure that the product is in conformity with this European Technical Assessment.

The manufacturer may only use initial / raw / constituent materials stated in the technical documentation of this European Technical Assessment.

The factory production control shall be in accordance with the Control Plan of 7th February 2023 relating to the European Technical Assessment ETA 23/0054 issued on 28/11/2023 which is part of the technical documentation of this European Technical Assessment. The “Control Plan” is laid down in the context of the factory production control system operated by the manufacturer and deposited at UL International (Netherlands) B.V.

The results of factory production control shall be recorded and evaluated in accordance with the provisions of the Control Plan.

Other tasks of the manufacturer:

Additional information

The manufacturer shall provide a technical data sheet and an installation instruction with the following minimum information:

(a) Technical data sheet:

- Field of application:
- Building elements for which the penetration seal is suitable, type and properties of the building elements like minimum thickness, density, and - in case of lightweight constructions - the construction requirements.
- Limits in size, minimum thickness etc. of the penetration seal
- Construction of the penetration seal including the necessary components and additional products (e.g. backfilling material) with clear indication whether they are generic or specific.
- Services which the penetration seal is suitable, type and properties of the services like material, diameter, thickness etc. in case of pipes including insulation materials; necessary/allowed supports/fixings (e.g. pipe trays)

(b) Installation instruction:

- Steps to be followed
- Procedure in case of retrofitting
- Stipulations on maintenance, repair and replacement

6. Issued on:

28 November 2023

Report by:



C. Johnson
Senior Staff Engineer
Built Environment

Verified by:



D. Yates
Staff Engineer
Built Environment

Validated by:



Erik Teubler
Head of TAB
Built Environment

For and on behalf of UL International (Netherlands) B.V.

Annex - Resistance to Fire Classification - Mulcol® Multiwrap

Annex A.1 - Flexible and rigid walls

A.1.1	Multimastic FB1 - 2x 50 mm - Combustible pipes	10
A.1.1.1	Plastic pipes	10
A.1.1.2	Plastic pipes with cables	12
A.1.1.3	Plastic pipes (Silent)	13
A.1.1.4	PP-R multilayer pipes	15
A.1.2	Multimortar + Multimastic FB - \geq 100 mm - Combustible pipes	16
A.1.2.1	Plastic pipes	16
A.1.2.2	Plastic pipes with cables	17
A.1.3	Multimortar 25 mm + Multimastic FB 50 mm + Multimortar 25 mm - \geq 100 mm - Combustible pipes	18
A.1.3.1	Plastic pipes	18
A.1.3.2	Plastic pipes with cables	19
A.1.4	Multimortar - \geq 100 mm - Combustible pipes	20
A.1.4.1	Plastic pipes	20
A.1.4.2	Plastic pipes with cables	21
A.1.5	Direct through wall - \geq 100 mm - Combustible pipes	22
A.1.5.1	Plastic pipes	22
A.1.5.2	Plastic pipes with cables	24
A.1.5.3	Plastic pipes (Silent)	25
A.1.5.4	PP-R multilayer pipes	27
A.1.6	Multimastic FB1 - 2x 50 mm - Metal pipes insulated elastomer	28
A.1.6.1	Copper and steel pipes - Elastomer LS 400 / CS	28
A.1.7	Multimortar + Multimastic FB - \geq 100 mm - Metal pipes insulated elastomer	30
A.1.7.1	Copper and steel pipes - Elastomer LS 400 / CS	30
A.1.8	Multimortar 25 mm + Multimastic FB 50 mm + Multimortar 25 mm - \geq 100 mm - Metal pipes insulated elastomer	32
A.1.8.1	Copper and steel pipes - Elastomer LS 400 / CS	32
A.1.9	Multimortar 100 mm - \geq 100 mm - Metal pipes insulated elastomer	34
A.1.9.1	Copper and steel pipes - Elastomer LS 400 / CS	34
A.1.10	Direct through wall - Metal pipes insulated elastomer	36
A.1.10.1	Copper and steel pipes - Elastomer LS 400 / CS	36

Annex A.2 - Rigid walls

A.2.1	Multimastic FB2 - 2x 60 mm 30 mm cavity - Combustible pipes	38
A.2.1.1	Plastic pipes	38
A.2.2	Direct through wall - Combustible pipes	39
A.2.2.1	Plastic pipes	39

Annex B.1 - Rigid floors

B.1.1	Multimortar - \geq 100 mm - Cables, trays and conduits	40
B.1.1.1	Plastic pipes with cables	40
B.1.2	Multimortar - \geq 150 mm - Cables, trays and conduits	41
B.1.2.1	Plastic pipes with cables	41
B.1.3	Multimastic FB1 - 2x 50 mm no cavity - Combustible pipes	42
B.1.3.1	Plastic pipes	42
B.1.3.2	Plastic pipes (Silent)	43
B.1.4	Multimastic FB1 - 2x 50 mm cavity 50 mm - Combustible pipes	44
B.1.4.1	Plastic pipes	44
B.1.4.2	Plastic pipes (Silent)	45
B.1.5	Multimastic FB2 - 1x 60 mm - Combustible pipes	46
B.1.5.1	Plastic pipes	46
B.1.6	Multimortar - \geq 100 mm - Combustible pipes	47
B.1.6.1	Plastic pipes	47
B.1.6.2	Plastic pipes (Silent)	49
B.1.7	Multimortar - \geq 150 mm - Combustible pipes	51
B.1.7.1	Plastic pipes	51
B.1.7.2	Plastic pipes (Silent)	53
B.1.8	Multimortar + Multimastic FB - \geq 100 mm - Combustible pipes	55
B.1.8.1	Plastic pipes	55
B.1.8.2	Plastic pipes (Silent)	56
B.1.9	Multimortar + Multimastic FB - \geq 150 mm - Combustible pipes	57
B.1.9.1	Plastic pipes	57
B.1.9.2	Plastic pipes (Silent)	58

B.1.10	Multimastic FB1 - 2x 50 mm no cavity - Metal pipes insulated elastomer	59
B.1.10.1	Copper and steel pipes - Elastomer LS 400 / CS	59
B.1.11	Multimastic FB1 - 2x 50 mm cavity 50 mm - Metal pipes insulated elastomer	60
B.1.11.1	Copper and steel pipes - Elastomer LS 400 / CS	60
B.1.12	Multimastic FB2 - 1x 60 mm - Metal pipes insulated elastomer	62
B.1.12.1	Steel pipes - Elastomer LS 400 / CS	62
B.1.13	Multimortar - ≥ 100 mm - Metal pipes insulated elastomer	63
B.1.13.1	Copper and steel pipes - Elastomer LS 400 / CS	63
B.1.14	Multimortar - ≥ 150 mm - Metal pipes insulated elastomer	65
B.1.14.1	Copper and steel pipes - Elastomer LS 400 / CS	65
B.1.15	Multimortar + Multimastic FB - ≥ 100 mm - Metal pipes insulated elastomer	67
B.1.15.1	Copper and steel pipes - Elastomer LS 400 / CS	67
B.1.16	Multimortar + Multimastic FB - ≥ 150 mm - Metal pipes insulated elastomer	68
B.1.16.1	Copper and steel pipes - Elastomer LS 400 / CS	68
Annex C - General		
C.1	Flexible and rigid wall - General	69
C.1.1	Mutual distances & distance to first support	69
C.1.2	Flexible and rigid wall - Maximum seal dimensions	70
C.1.2.1	2x 50 mm no aperture framing	70
C.1.2.2	2x 50 mm with aperture framing	71
C.1.2.3	Multimastic FB1 - 2x 50 mm - Pattress	72
C.1.2.4	Multimastic FB2 - 1x 60 mm with aperture framing	73
C.1.2.5	Multimastic FB2 - 1x 60 mm with aperture framing	74
C.1.3	Rigid wall - General - Maximum seal dimensions	75
C.1.3.1	Multimastic FB2 - 2x 60 mm with cavity ≤ 30 mm	75
C.1.3.2	Multimastic FB2 - 2x 60 mm - Pattress fixed to wall	76
C.1.4	Flexible and rigid wall - Maximum seal dimensions	77
C.1.4.1	Multimortar - ≥ 100 mm	77
C.1.4.2	Multimortar + Mulcol Multimastic FB system - ≥ 100 mm	78
C.1.4.3	Multimortar 25 mm + Multimastic FB 50 mm + Multimortar 25 mm - ≥ 100 mm	79
C.2	Rigid floor - General	80
C.2.1	Mutual distances & distance to first support	80
C.2.2	Rigid floor - General - Maximum seal dimensions	81
C.2.2.1	Multimastic FB1 - 2x 50 mm no cavity	81
C.2.2.2	Multimastic FB1 - 2x 50 mm cavity ≤ 50 mm	88
C.2.2.3	Multimastic FB2 - 1x 60 mm	83
C.2.3	Rigid floor - General - Maximum seal dimensions	84
C.2.3.1	Multimortar - ≥ 100 mm	84
C.2.3.2	Multimortar + Mulcol Multimastic FB system - ≥ 100 mm	85
C.2.3.3	Multimortar + Mulcol Multimastic FB system - ≥ 150 mm	86
C.3	Wall configurations	87
C.3.1	Allowed wall configurations	87

A.1.1 Multimastic FB1 - 2x 50 mm - Combustible pipes

A.1.1.1 Plastic pipes

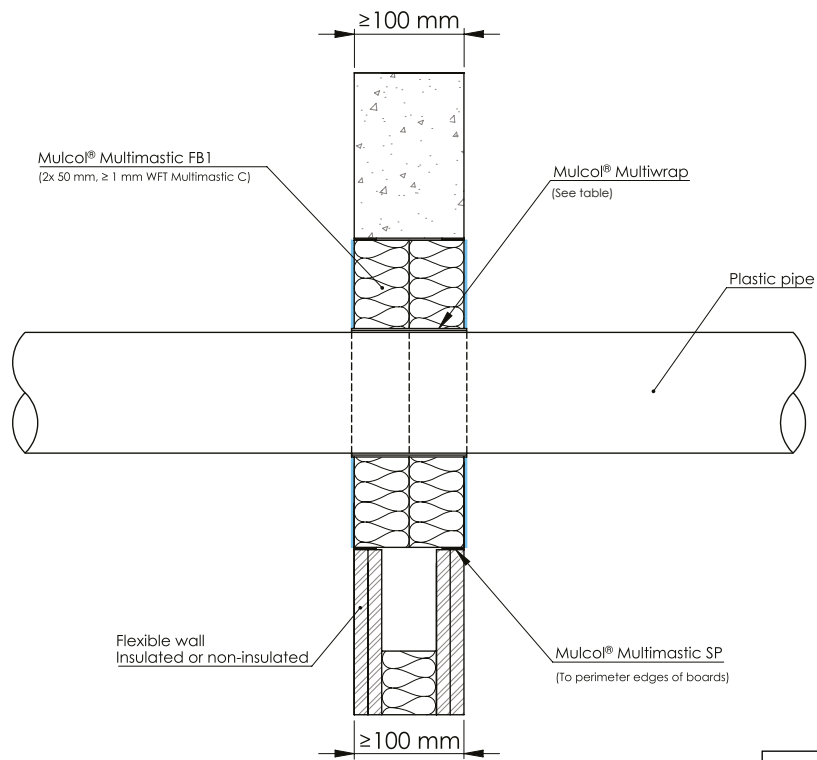
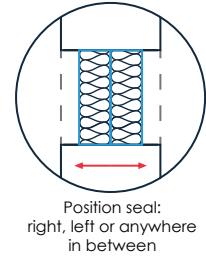
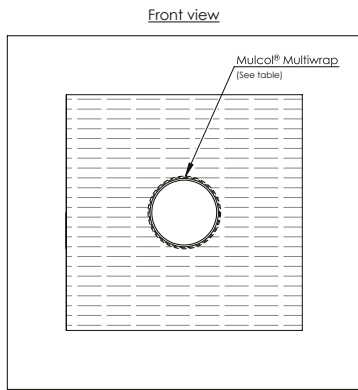

Drawing: PBfw.E-PP-MW2-MFB1.2.10

Services	Pipe dimensions (mm)		Product	Classification
	Outer dimension	Wall thickness		
PE(-HD) / PE / ABS / SAN+PVC	≤ Ø 40	2.3 - 3.7	Multiwrap (2 layers)	EI 120 U/U
	≤ Ø 110	2.7 - 10		EI 120 U/C
PP	≤ Ø 40	2.3 - 3.7		EI 120 U/U
	≤ Ø 110	3.4		EI 120 U/C
PVC(-U/-C)	≤ Ø 40	1.8 - 3.7		EI 120 U/U
	≤ Ø 110	1.6		EI 90 U/C, E 120 U/C
		1.6 - 8.1		EI 90 U/C

A.1.1 Multimastic FB1 - 2x 50 mm - Combustible pipes**A.1.1.1 Plastic pipes**

Services	Pipe dimensions (mm)		Product	Classification
	Outer dimension	Wall thickness		
PE(-HD) / PE / ABS / SAN+PVC	≤ Ø 125	3.9	Multiwrap (3 layers)	EI 120 U/C
		3.9 - 4.8		EI 90 U/C, E 120 U/C
PP		3.1		EI 120 U/C
PVC(-U/-C)		3.1 - 11.4		EI 90 U/C, E 120 U/C
		3.7 - 4.8		

Services	Pipe dimensions (mm)		Product	Classification
	Outer dimension	Wall thickness		
PP	≤ Ø 110	10.0	Multiwrap (4 layers)	EI 120 U/U
		10.0 - 14.6		EI 90 U/U
PE(-HD) / PE-X / ABS / SAN+PVC	≤ Ø 160	14.6		EI 90 U/C
PVC(-U/-C)		5.0		EI 90 U/C, E 120 U/C
		5.0 - 14.6	EI 90 U/C	

Services	Pipe dimensions (mm)		Product	Classification
	Outer dimension	Wall thickness		
PE(-HD) / PE / ABS / SAN+PVC	≤ Ø 125	11.4	Multiwrap (5 layers)	EI 120 U/U
PVC(-U/-C)		9.2		

A.1.1 Multimastic FB1 - 2x 50 mm - Combustible pipes

A.1.1.2 Plastic pipes with cables

Front view

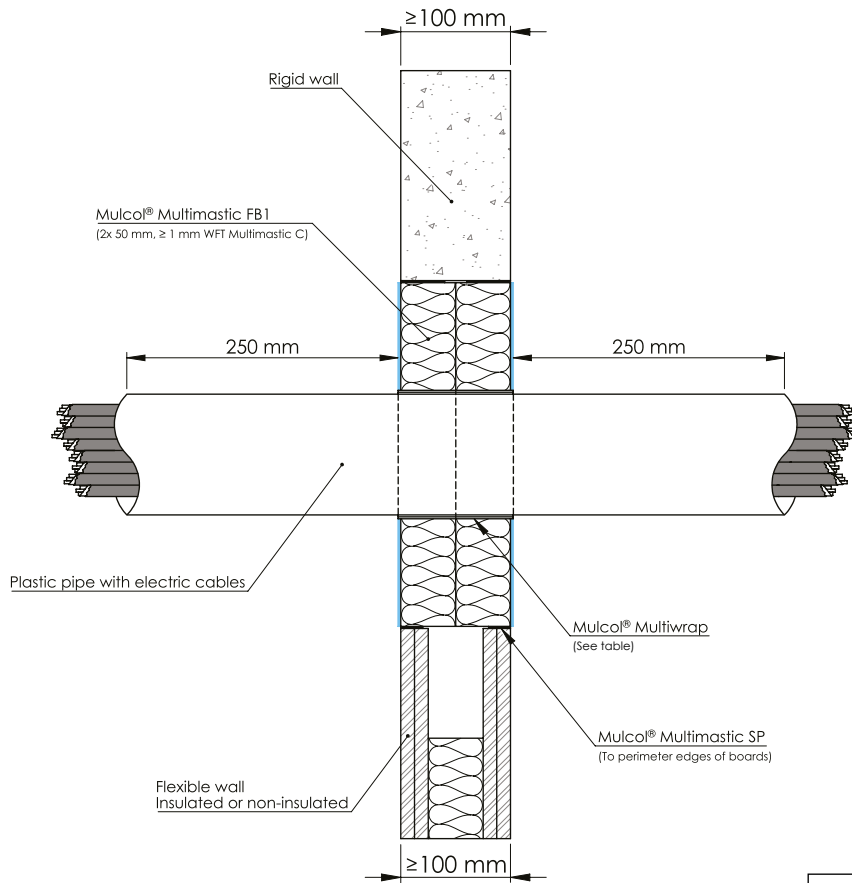
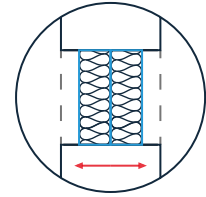
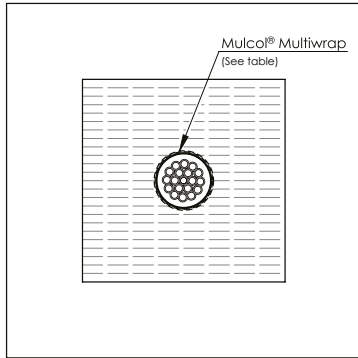

Drawing: PBfw.E-PPEC-MW2-MFB1.2.10

Services	Pipe dimensions (mm)		Product	Allowed Cables	Classification
	Outer dimension	Wall thickness			
PE(-HD) / PE-X / ABS / SAN+PVC	≤ Ø 110	2.7 - 10	Multiwrap (2 layers)	Sheathed cables ≤ Ø 80 mm (single or bundled) Cables ≤ Ø 21 mm in a tied bundle ≤ Ø 100 mm	EI 90 U/C, E 120 U/C
PP					
PVC(-U/-C)					

A.1.1 Multimastic FB1 - 2x 50 mm - Combustible pipes

A.1.1.3 Plastic pipes (Silent)

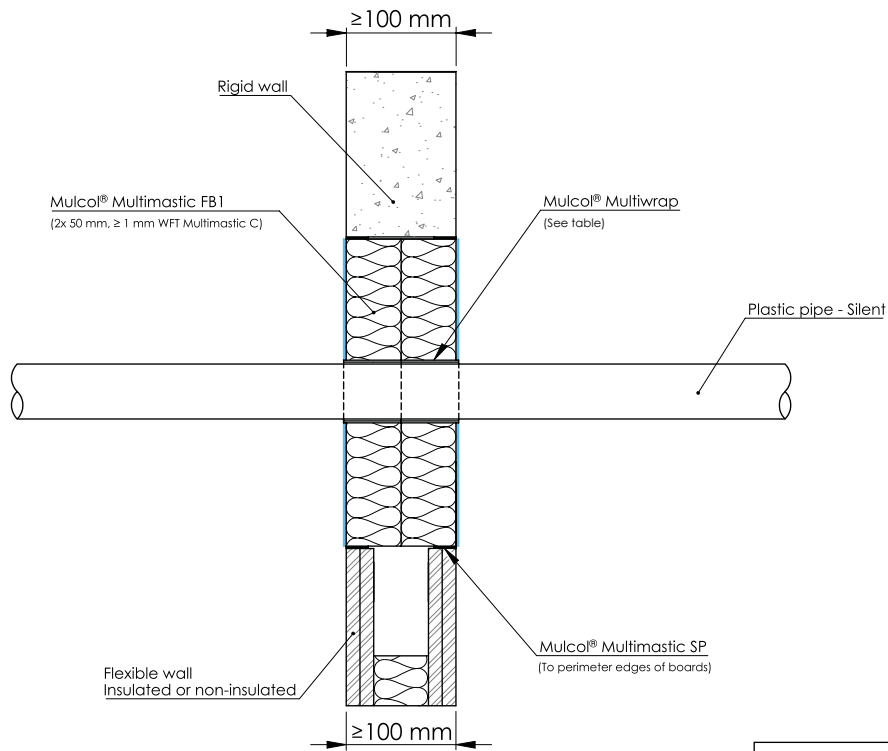
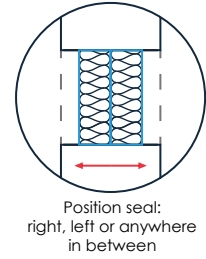
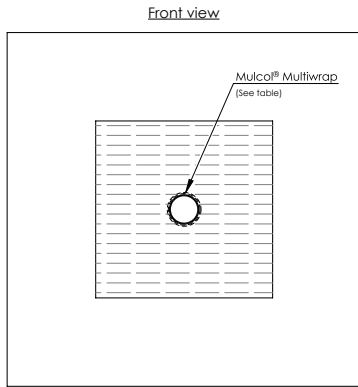

Drawing: PBfw.E-PPS-MW2-MFB1.2.10

Services	Pipe dimensions (mm)		Product	Classification
	Outer dimension	Wall thickness		
Raupiano Plus	≤ Ø 50	1.8 - 2.7	Multiwrap (2 layers)	EI 120 U/C
	≤ Ø 110	2.7		
Geberit Silent dB20	≤ Ø 56	3.2 - 6.0		
	≤ Ø 110	6.0		
Wavin SiTech+	≤ Ø 40	2.0		
	≤ Ø 40	2.0 - 3.4		
	≤ Ø 50	1.8		
	≤ Ø 110	3.4		
Poloplast PoloKal NG	≤ Ø 50	2.0		EI 120 U/C

A.1.1 Multimastic FB1 - 2x 50 mm - Combustible pipes**A.1.1.3 Plastic pipes (Silent)**

Services	Pipe dimensions (mm)		Product	Classification
	Outer dimension	Wall thickness		
Raupiano Plus	≤ Ø 110	2.7	Multiwrap (4 layers)	EI 120 U/U
	≤ Ø 160	4.0		EI 90 U/C, E 120 U/C
Poloplast PoloKal NG	≤ Ø 110	3.4		EI 120 U/C

Services	Pipe dimensions (mm)		Product	Classification
	Outer dimension	Wall thickness		
Raupiano Plus	≤ Ø 160	3.9	Multiwrap (6 layers)	EI 120 U/U
Poloplast PoloKal NG	≤ Ø 160	4.9		EI 90 U/C, E 120 U/C

A.1.1 Multimastic FB1 - 2x 50 mm - Combustible pipes

A.1.1.4 PP-R multilayer pipes

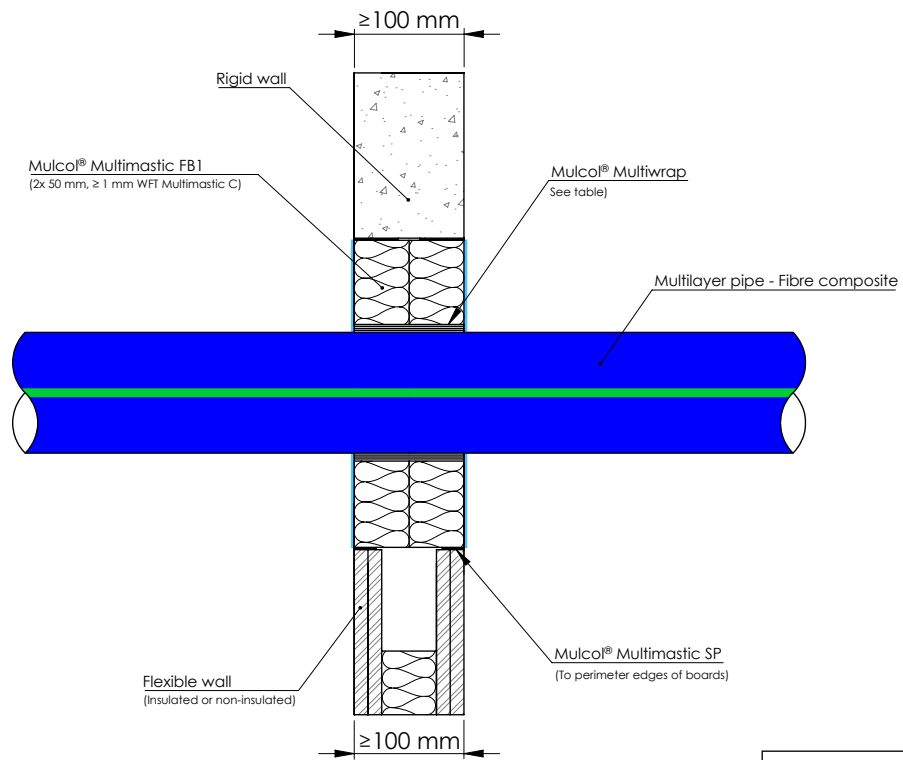
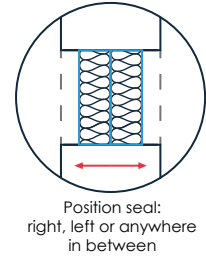
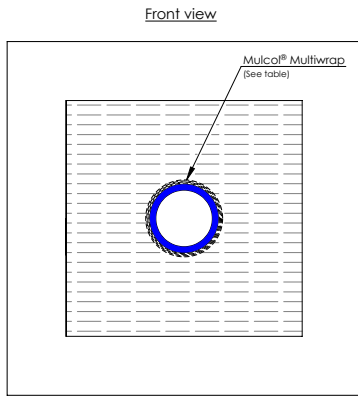

Drawing: PBfw.E-MLF-MW4-MFB1.2.10

Services	Pipe dimensions (mm)		Product	Classification
	Outer dimension	Wall thickness		
Aquatherm Blue	≤ Ø 40	3.7	Multiwrap (2 layers)	EI 120 U/C
	≤ Ø 50	4.6		EI 120 U/U
	≤ Ø 110	10	Multiwrap (4 layers)	EI 120 U/C

A.1.2 Multimortar + Multimastic FB - ≥ 100 mm - Combustible pipes

A.1.2.1 Plastic pipes

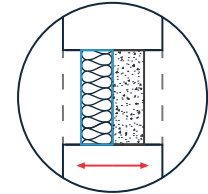
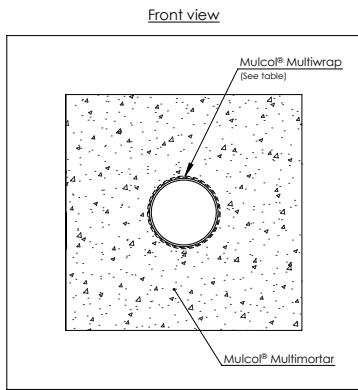

Position seal:
right, left or any in between

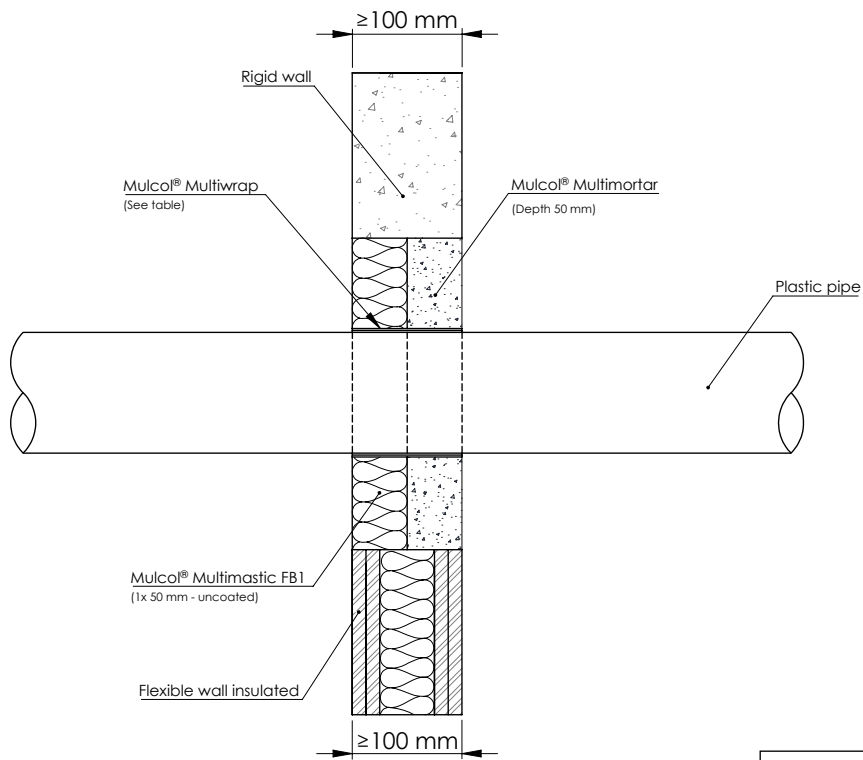

Drawing: FW.E-PP-MW2-MM2.5.10

Services	Pipe dimensions (mm)		Product	Classification
	Outer dimension	Wall thickness		
PP	$\leq \text{Ø } 110$	10.0	Multiwrap (2 layers)	EI 120 U/C
			Multiwrap (4 layers)	EI 120 U/U

A.1.2 Multimortar + Multimastic FB - ≥ 100 mm - Combustible pipes

A.1.2.2 Plastic pipes with cables

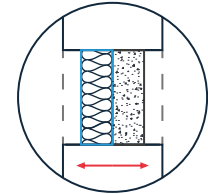
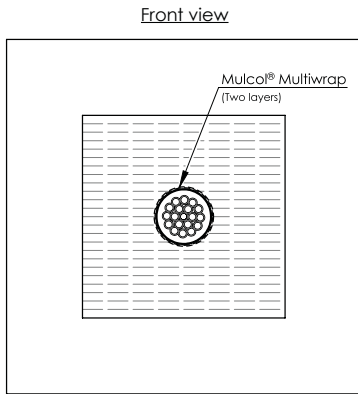

Position seal:
right, left or any in between

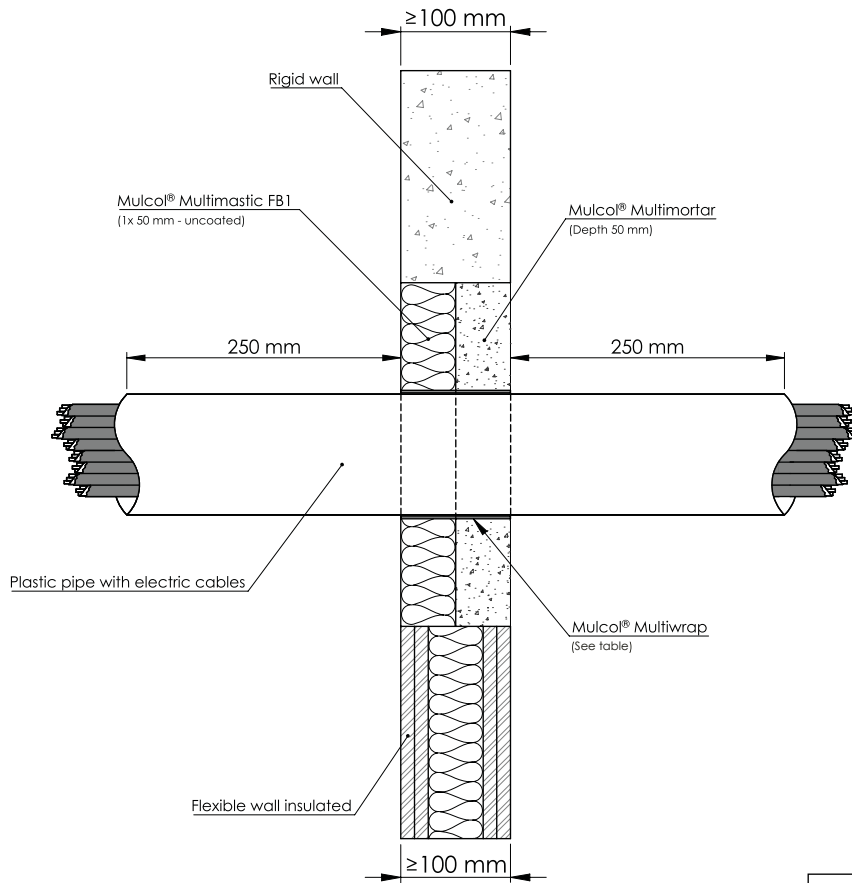

Drawing: FW.E-PPEC-MW2-MM2.5.10

Services	Pipe dimensions (mm)		Product	Allowed Cables	Classification
	Outer dimension	Wall thickness			
PE(-HD) / PE-X / ABS / SAN+PVC	$\leq \text{Ø } 110$	2.7 - 10	Multiwrap (2 layers)	Sheathed cables $\leq \text{Ø } 80$ mm (single or bundled) Cables $\leq \text{Ø } 21$ mm in a tied bundle $\leq \text{Ø } 100$ mm	EI 90 U/C, E 120 U/C
PP					
PVC(-U/-C)					

A.1.3

Multimortar 25 mm + Multimastic FB 50 mm + Multimortar 25 mm - ≥ 100 mm - Combustible pipes

A.1.3.1

Plastic pipes

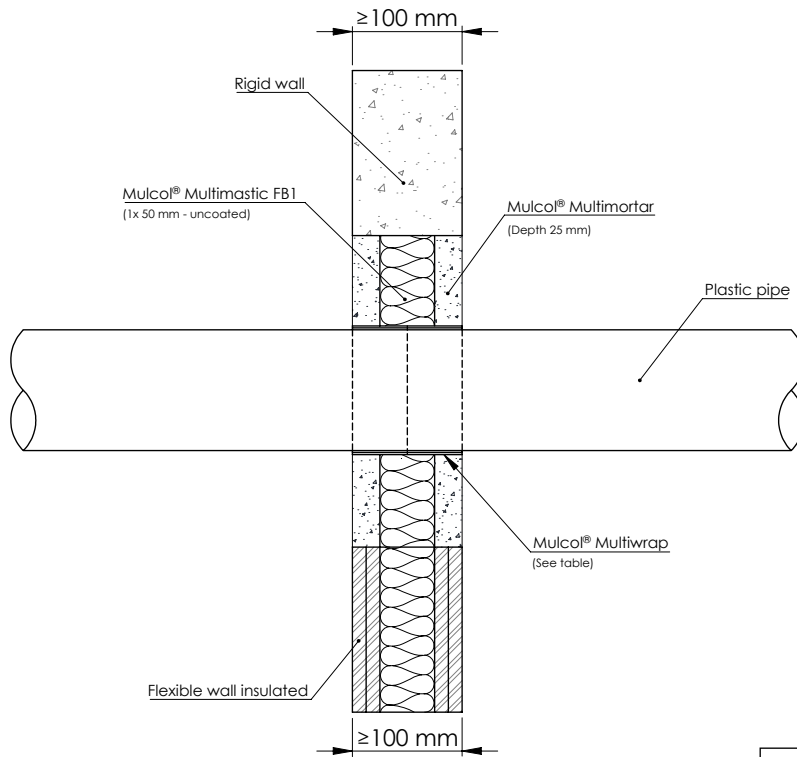
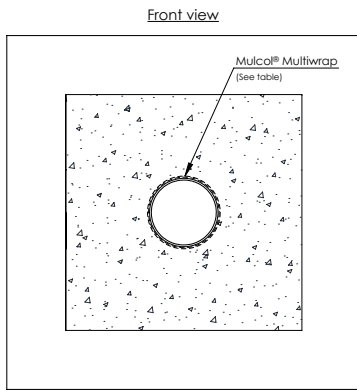

Drawing: FW.E-PP-MW2-MM3.4.10

Services	Pipe dimensions (mm)		Product	Classification
	Outer dimension	Wall thickness		
PP	$\leq \text{Ø } 110$	10.0	Multiwrap (2 layers)	EI 120 U/C
			Multiwrap (4 layers)	EI 120 U/U

A.1.3

Multimortar 25 mm + Multimastic FB 50 mm + Multimortar 25 mm - ≥ 100 mm - Combustible pipes

A.1.3.2

Plastic pipes with cables

Front view

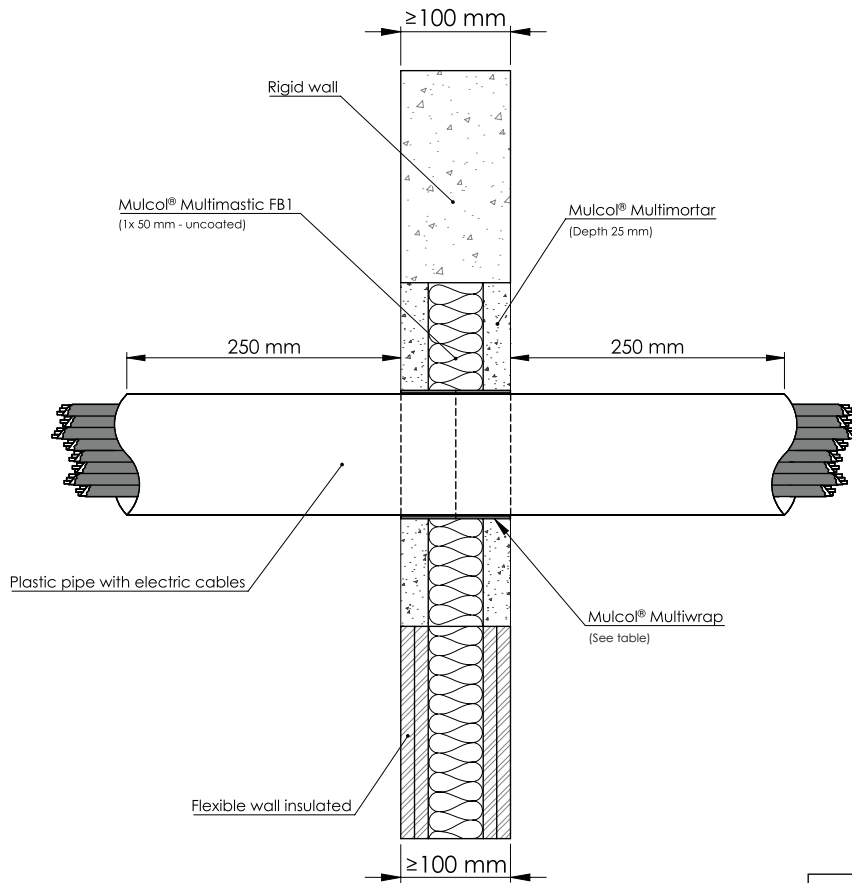
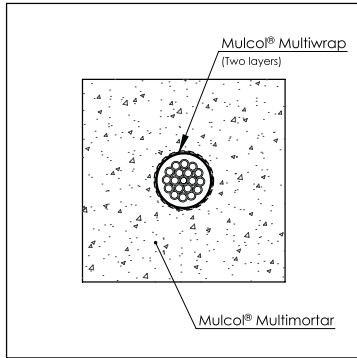

Drawing: FW.E-PPEC-MW2-MM3.4.10

Services	Pipe dimensions (mm)		Product	Allowed Cables	Classification
	Outer dimension	Wall thickness			
PE(-HD) / PE-X / ABS / SAN+PVC	$\leq \text{Ø } 110$	2.7 - 10	Multiwrap (2 layers)	Sheathed cables $\leq \text{Ø } 80$ mm (single or bundled) Cables $\leq \text{Ø } 21$ mm in a tied bundle $\leq \text{Ø } 100$ mm	EI 90 U/C, E 120 U/C
PP					
PVC(-U/-C)					

A.1.4 Multimortar - ≥ 100 mm - Combustible pipes

A.1.4.1 Plastic pipes

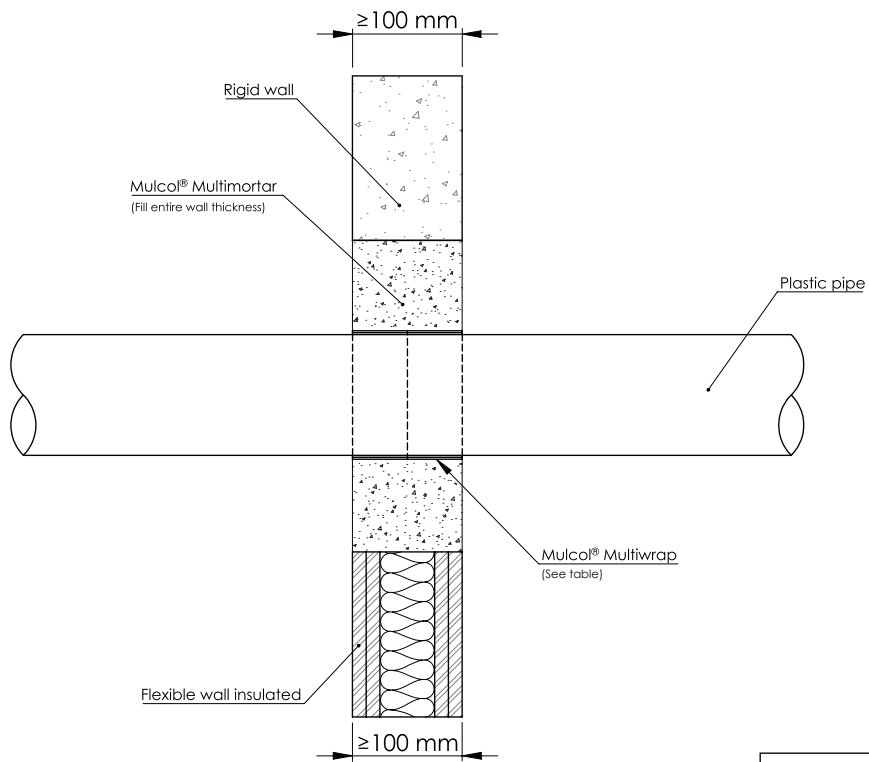
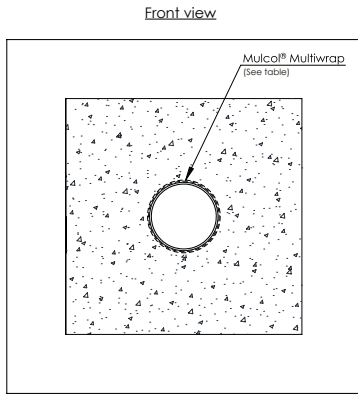

Drawing: FW.E-PP-MW2-MM1.2.10-T

Services	Pipe dimensions (mm)		Product	Classification
	Outer dimension	Wall thickness		
PP	$\leq \text{Ø } 110$	10.0	Multiwrap (2 layers)	EI 120 U/C
			Multiwrap (4 layers)	EI 120 U/U

A.1.4 Multimortar - ≥ 100 mm - Combustible pipes

A.1.4.2 Plastic pipes with cables

Front view

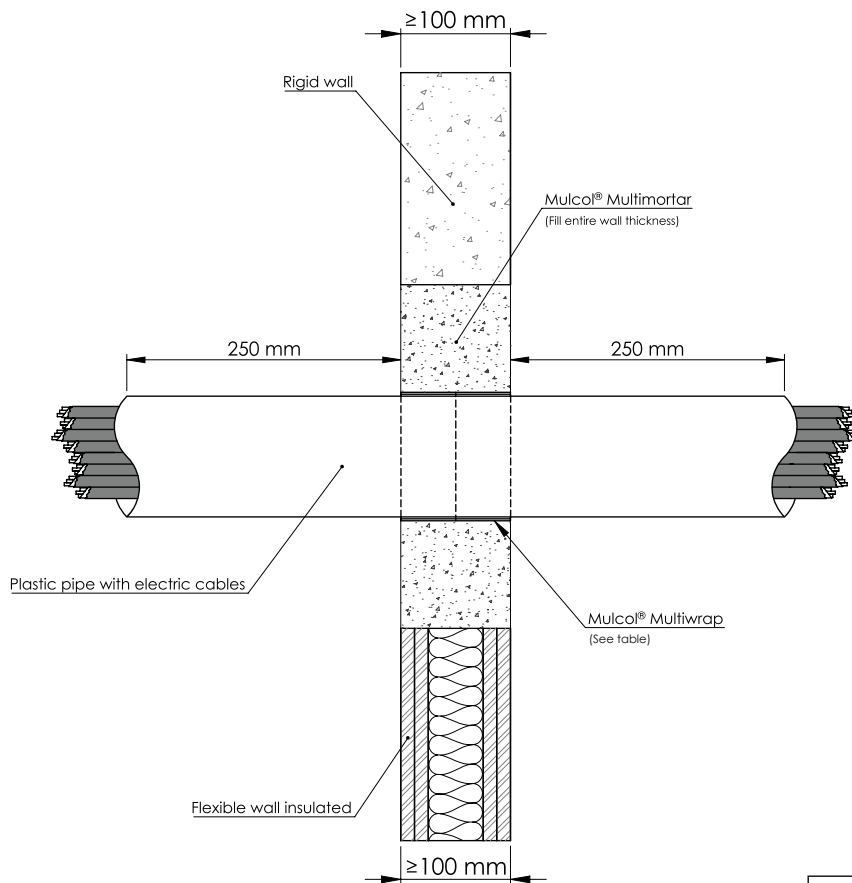
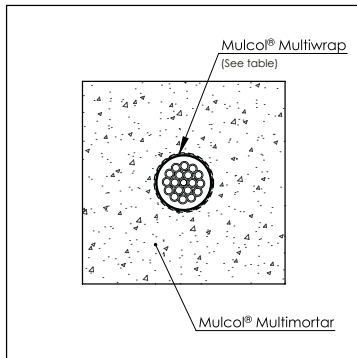

Drawing: FW.E-PPEC-MW2-MM1.2.10

Services	Pipe dimensions (mm)		Product	Allowed Cables	Classification
	Outer dimension	Wall thickness			
PE(-HD) / PE-X / ABS / SAN+PVC	$\leq \text{Ø } 110$	2.7 - 10	Multiwrap (2 layers)	Sheathed cables $\leq \text{Ø } 80$ mm (single or bundled) Cables $\leq \text{Ø } 21$ mm in a tied bundle $\leq \text{Ø } 100$ mm	EI 90 U/C, E 120 U/C
PP					
PVC(-U/-C)					

A.1.5 Direct through wall - ≥ 100 mm - Combustible pipes

A.1.5.1 Plastic pipes

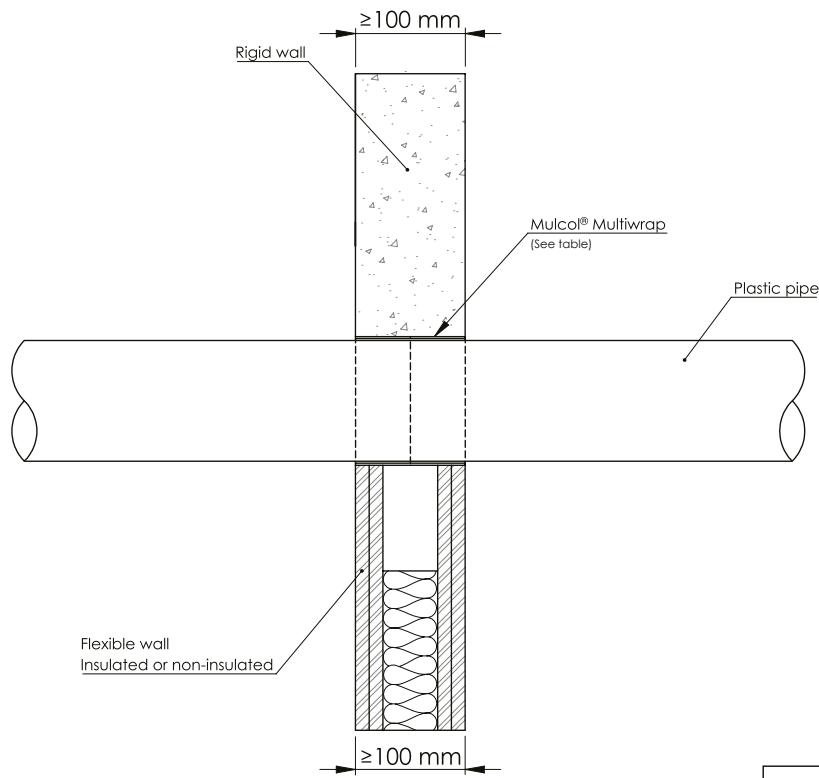
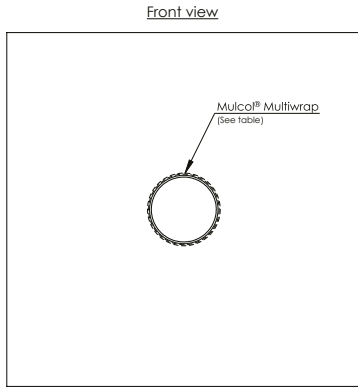

Drawing: FW.E-PP-MW2.1.2

Services	Pipe dimensions (mm)		Product	Classification
	Outer dimension	Wall thickness		
PE(-HD) / PE-X / ABS / SAN+PVC	$\leq \text{Ø } 40$	2.3 - 3.7	Multiwrap (2 layers)	EI 120 U/U
	$\leq \text{Ø } 110$	2.7 - 10		EI 120 U/C
PP	$\leq \text{Ø } 40$	2.3 - 3.7		EI 120 U/U
		5.5		EI 120 U/C
PVC(-U/-C)	$\leq \text{Ø } 110$	3.4		EI 120 U/C
	$\leq \text{Ø } 40$	1.8 - 3.7		EI 120 U/U
		1.6		E 120 U/C, EI 90 U/C
		1.6 - 8.1		EI 90 U/C

A.1.5 Direct through wall - ≥ 100 mm - Combustible pipes**A.1.5.1 Plastic pipes**

Services	Pipe dimensions (mm)		Product	Classification
	Outer dimension	Wall thickness		
PE(-HD) / PE / ABS / SAN+PVC	$\leq \varnothing 125$	3.9	Multiwrap (3 layers)	EI 120 U/C
		3.9 - 4.8		EI 90 U/C, E 120 U/C
PP		3.1		EI 120 U/C
PVC(-U/-C)		3.1 - 11.4		EI 90 U/C, E 120 U/C
		3.7 - 4.8		

Services	Pipe dimensions (mm)		Product	Classification
	Outer dimension	Wall thickness		
PP	$\leq \varnothing 110$	10	Multiwrap (4 layers)	EI 120 U/U
		10 - 14.6		EI 90 U/U
PE(-HD) / PE-X / ABS / SAN+PVC	$\leq \varnothing 160$	14.6		EI 90 U/C
		5.0		EI 90 U/C, E 120 U/C
PVC(-U/-C)		5.0 - 14.6	EI 90 U/C	

Services	Pipe dimensions (mm)		Product	Classification
	Outer dimension	Wall thickness		
PE(-HD) / PE / ABS / SAN+PVC	$\leq \varnothing 125$	11.4	Multiwrap (5 layers)	EI 120 U/U
PVC(-U/-C)		9.2		

A.1.5 Direct through wall - ≥ 100 mm - Combustible pipes

A.1.5.2 Plastic pipes with cables

Front view

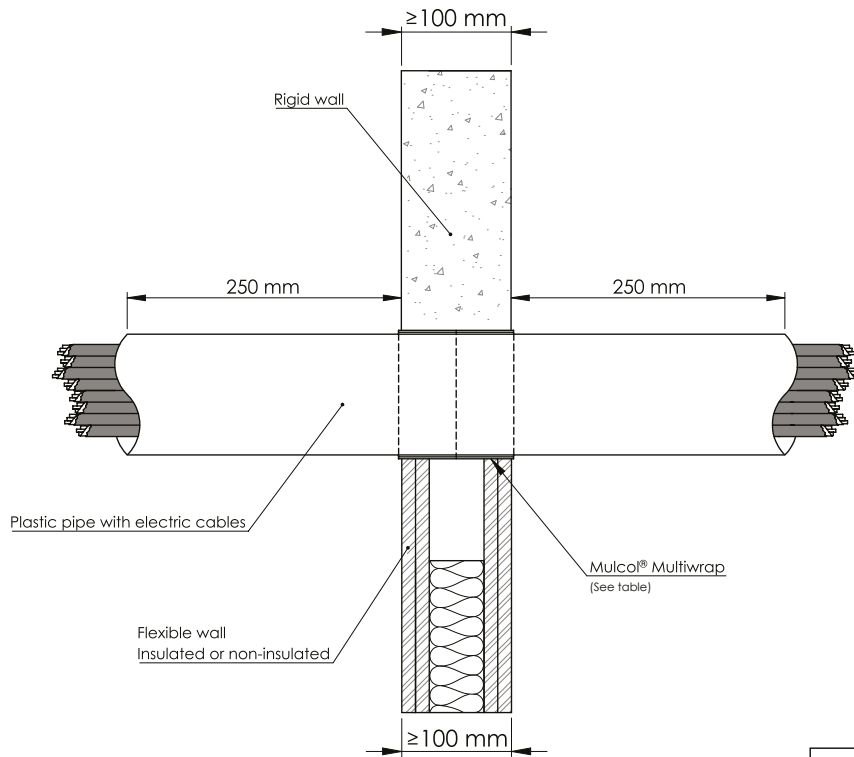
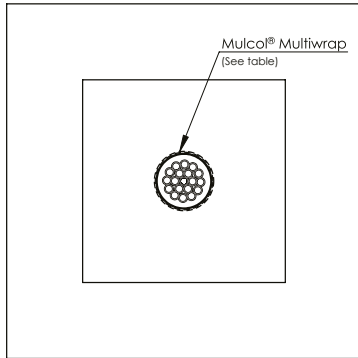

Drawing: FW.E-PPEC-MW2.2.2

Services	Pipe dimensions (mm)		Product	Allowed Cables	Classification
	Outer dimension	Wall thickness			
PE(-HD) / PE-X / ABS / SAN+PVC	$\leq \text{Ø } 110$	2.7 - 10	Multiwrap (2 layers)	Sheathed cables $\leq \text{Ø } 80$ mm (single or bundled) Cables $\leq \text{Ø } 21$ mm in a tied bundle $\leq \text{Ø } 100$ mm	EI 90 U/C, E 120 U/C
PP					
PVC(-U/-C)					

A.1.5 Direct through wall - ≥ 100 mm - Combustible pipes

A.1.5.3 Plastic pipes (Silent)

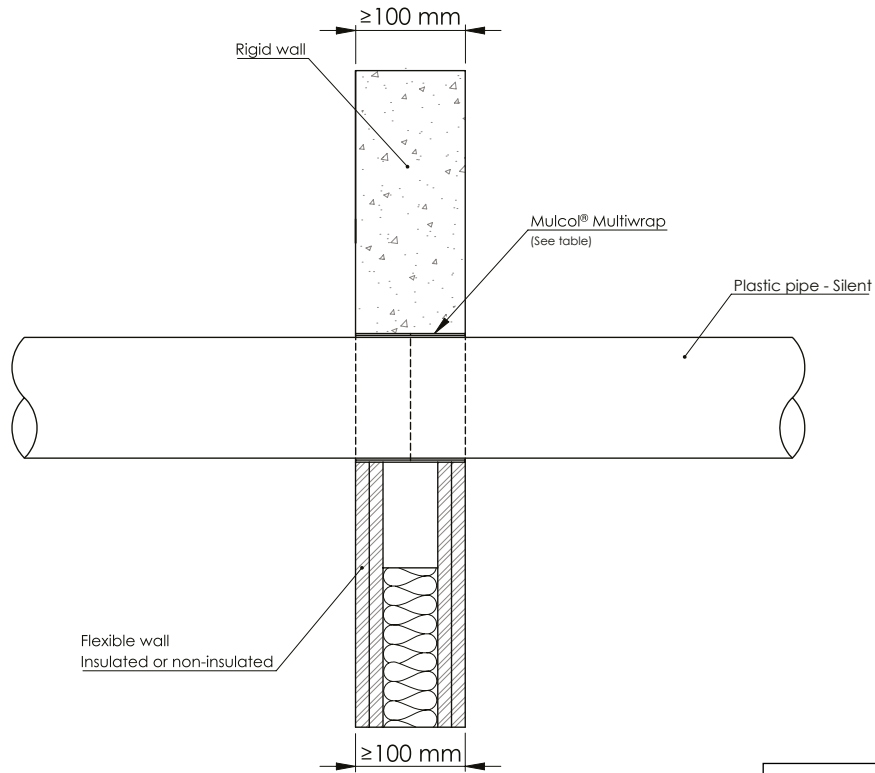
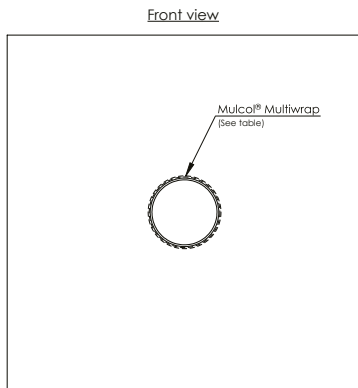

Drawing: FW.E-PPS-MW2.1.2

Services	Pipe dimensions (mm)		Product	Classification
	Outer dimension	Wall thickness		
Raupiano Plus	$\leq \text{Ø } 50$	1.8 - 2.7	Multiwrap (2 layers)	EI 120 U/C
	$\leq \text{Ø } 110$	2.7		
Geberit Silent dB20	$\leq \text{Ø } 56$	3.2 - 6.0		
	$\leq \text{Ø } 110$	6.0		
Wavin SiTech+	$\leq \text{Ø } 40$	2.0		EI 120 U/U
		2.0 - 3.4		EI 120 U/C
	$\leq \text{Ø } 50$	1.8		EI 120 U/U
	$\leq \text{Ø } 110$	3.4		
Poloplast PoloKal NG	$\leq \text{Ø } 50$	2.0		EI 120 U/C

A.1.5 Direct through wall - ≥ 100 mm - Combustible pipes**A.1.5.3 Plastic pipes (Silent)**

Services	Pipe dimensions (mm)		Product	Classification
	Outer dimension	Wall thickness		
Poloplast PoloKal NG	$\leq \varnothing 110$	3.4	Multiwrap (4 layers)	EI 120 U/C
Raupiano Plus		2.7		EI 120 U/U
	$\leq \varnothing 160$	4.0		EI 90 U/C, E 120 U/C

Services	Pipe dimensions (mm)		Product	Classification
	Outer dimension	Wall thickness		
Raupiano Plus	$\leq \varnothing 160$	3.9	Multiwrap (6 layers)	EI 120 U/U
Poloplast PoloKal NG		4.9		EI 90 U/C, E 120 U/C

A.1.5 Direct through wall - ≥ 100 mm - Combustible pipes

A.1.5.4 PP-R multilayer pipes

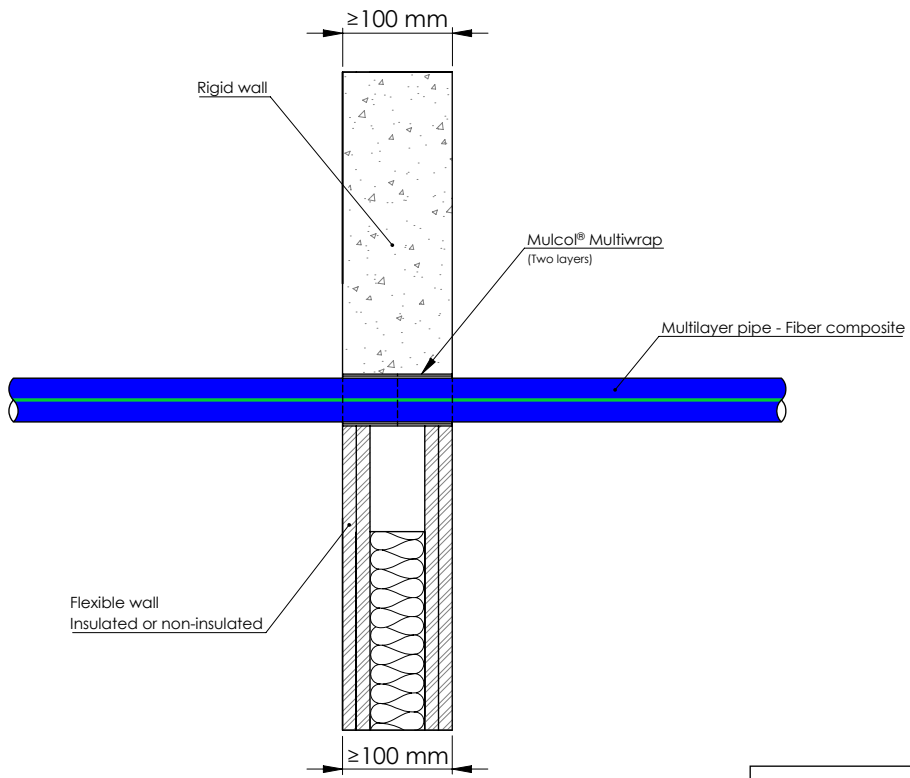
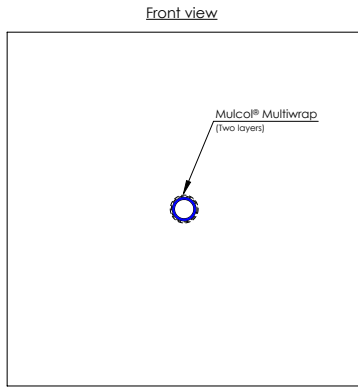

Drawing: FW-MLF-MW2.1.2

Services	Pipe dimensions (mm)		Product	Classification
	Outer dimension	Wall thickness		
Aquatherm Blue	$\leq \text{Ø } 40$	3.7	Multiwrap (2 layers)	EI 120 U/C
	$\leq \text{Ø } 50$	4.6		EI 120 U/U
	$\leq \text{Ø } 110$	10	Multiwrap (4 layers)	EI 120 U/C

A.1.6 Multimastic FB1 - 2x 50 mm - Metal pipes insulated elastomer

A.1.6.1 Copper and steel pipes - Elastomer LS 400 / CS

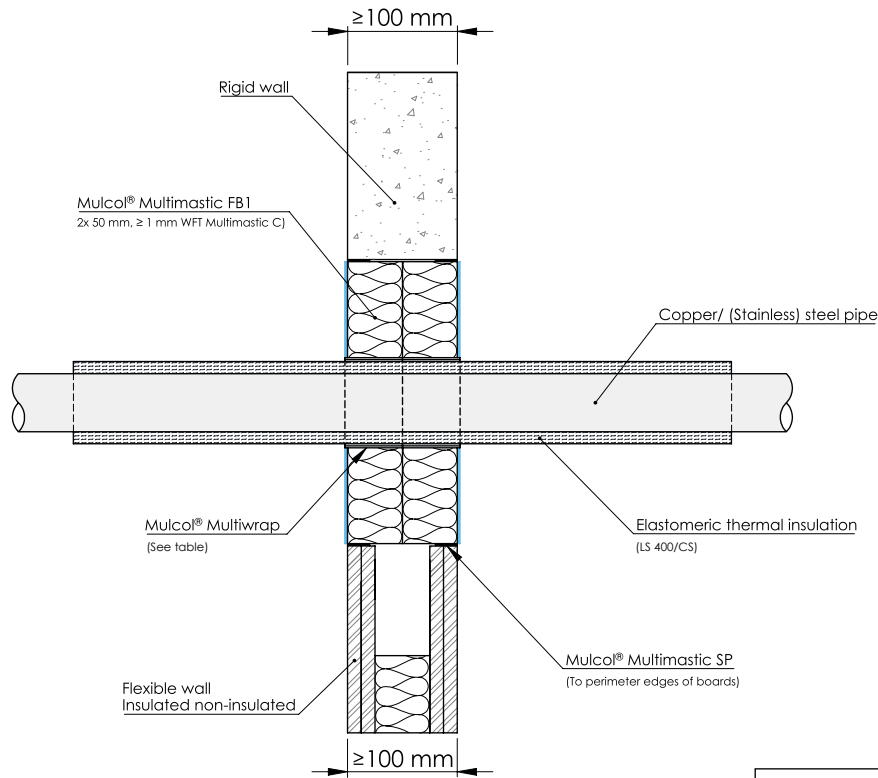
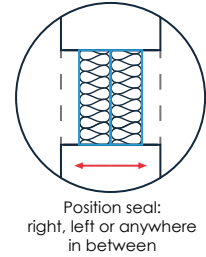
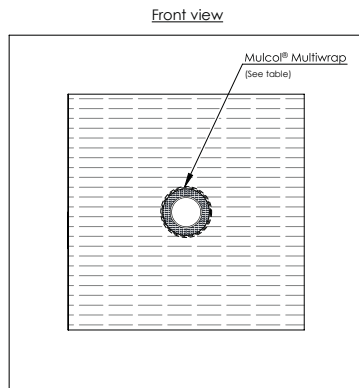

Drawing: PBfw.E-CU-MW2-MFB1.2.22

Services	Pipe dimensions (mm)		Insulation			Product	Classification
	Outer dimension	Wall thickness	Type	Thickness (mm)	Configuration		
Copper / (stainless) steel / cast iron	≤ Ø 12	≥ 1.0	ArmaFlex AF (min. class B-s3, d0 B _L -s3, d0)	9	LS 400 / CS	Multiwrap (2 layers)	EI 120 C/U, E 180 C/U
	≤ Ø 35	≥ 1.1		35			EI 90 C/U, E 120 C/U
	≤ Ø 54	≥ 1.5		60		Multiwrap (3 layers)	EI 120 C/U
				38			EI 90 C/U, E 120 C/U
(Stainless) Steel / cast iron	≤ Ø 114.3	≥ 3.6		15	LS 400 / CS	Multiwrap (2 layers)	EI 60 C/U, E 120 C/U
	≤ Ø 219.1	≥ 4.0		32			CS
						≤ Ø 324	≥ 3.7
	Multiwrap (3 layers)	EI 60 C/U, E 120 C/U					
		CS	EI 45 C/U, E 180 C/U				
					Multiwrap (3 layers)	EI 90 C/U, E 180 C/U	

A.1.6 Multimastic FB1 - 2x 50 mm - Metal pipes insulated elastomer

A.1.6.1 Copper and steel pipes - Elastomer LS 400 / CS

Services	Pipe dimensions (mm)		Insulation			Product	Classification
	Outer dimension	Wall thickness	Type	Thickness (mm)	Configuration		
Copper / (stainless) steel / cast iron	≤ Ø 22	≥ 1.0	Kaiflex ST (min. class B-s3, d0 B _L -s3, d0)	9 - 32	LS 400 / CS	Multiwrap (2 layers)	EI 90 C/U, E 120 C/U
				32			EI 120 C/U
≤ Ø 54	≥ 1.5	13 - 32		EI 30 C/U, E 120 C/U			
		32		EI 60 C/U, E 120 C/U			
(Stainless) Steel / cast iron	≤ Ø 114.3	≥ 3.6		13			EI 60 C/U, E 120 C/U
	≤ Ø 168.3	≥ 4.5		13 - 32			EI 45 C/U, E 120 C/U
			32	EI 60 C/U, E 120 C/U			

A.1.7 Multimortar + Multimastic FB - ≥ 100 mm - Metal pipes insulated elastomer

A.1.7.1 Copper and steel pipes - Elastomer LS 400 / CS

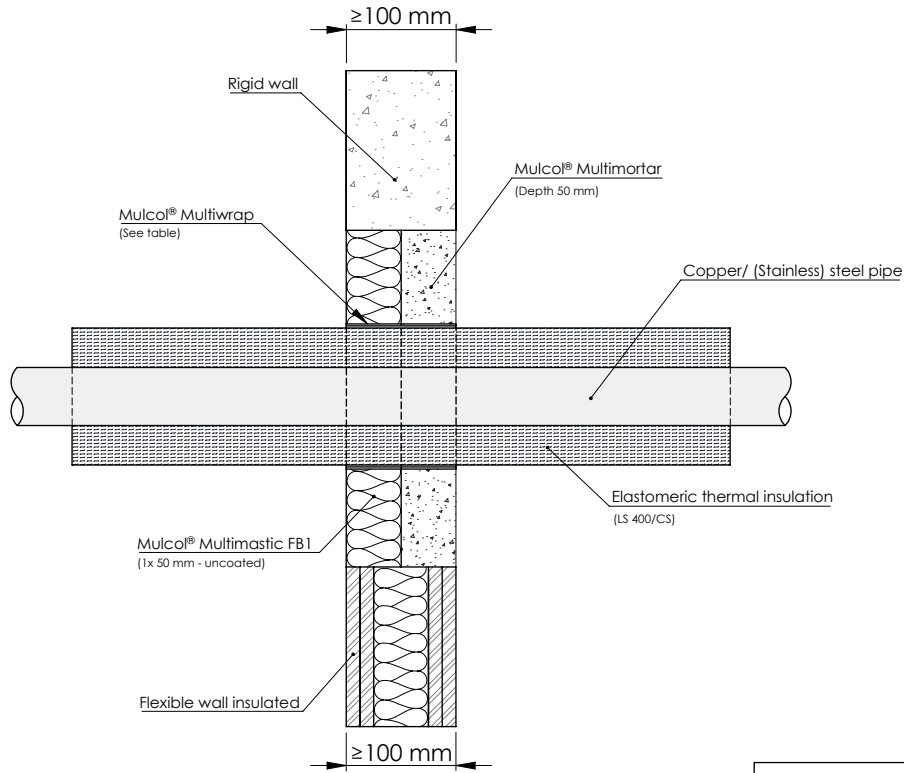
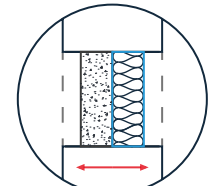
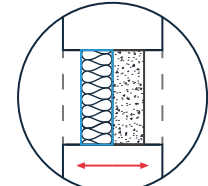
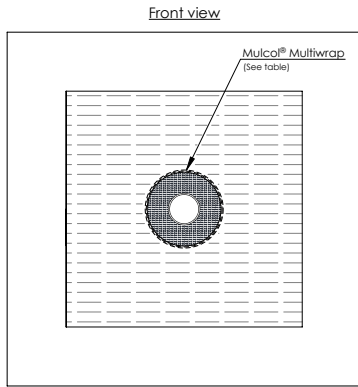

Drawing: FW.E-CU-MW2-MM2.5.22

Services	Pipe dimensions (mm)		Insulation			Product	Classification
	Outer dimension	Wall thickness	Type	Thickness (mm)	Configuration		
Copper / (stainless) steel / cast iron	≤ Ø 12	≥ 1.0	ArmaFlex AF (min. class B-s3, d0 B _L -s3, d0)	9	LS 400 / CS	Multiwrap (2 layers)	EI 120 C/U, E 180 C/U
	≤ Ø 35	≥ 1.1		35			EI 90 C/U, E 120 C/U
	≤ Ø 54	≥ 1.5		60			EI 120 C/U
(Stainless) Steel / cast iron	≤ Ø 114.3	≥ 3.6		38	CS		EI 60 C/U, E 120 C/U
	≤ Ø 219.1	≥ 4.0		15			EI 45 C/U, E 120 C/U
	≤ Ø 324	≥ 3.7		50	32		LS 400 / CS
			50		CS	EI 60 C/U, E 120 C/U	
					Multiwrap (3 layers)	EI 45 C/U, E 180 C/U	
						EI 90 C/U, E 180 C/U	

A.1.7 Multimortar + Multimastic FB - ≥ 100 mm - Metal pipes insulated elastomer

A.1.7.1 Copper and steel pipes - Elastomer LS 400 / CS

Services	Pipe dimensions (mm)		Insulation			Product	Classification
	Outer dimension	Wall thickness	Type	Thickness (mm)	Configuration		
Copper / (stainless) steel / cast iron	$\leq \varnothing 22$	≥ 1.0	Kaiflex ST (min. class B-s3, d0 B _L -s3, d0)	9 - 32	LS 400 / CS	Multiwrap (2 layers)	EI 90 C/U, E 120 C/U
				32			EI 120 C/U
$\leq \varnothing 54$	≥ 1.5	13 - 32		EI 30 C/U, E 120 C/U			
		32		EI 60 C/U, E 120 C/U			
(Stainless) Steel / cast iron	$\leq \varnothing 114.3$	≥ 3.6		13			EI 45 C/U, E 120 C/U
	$\leq \varnothing 168.3$	≥ 4.5		13 - 32			EI 60 C/U, E 120 C/U
			32	EI 60 C/U, E 120 C/U			

A.1.8

Multimortar 25 mm + Multimastic FB 50 mm + Multimortar 25 mm - ≥ 100 mm - Metal pipes insulated elastomer

A.1.8.1

Copper and steel pipes - Elastomer LS 400 / CS

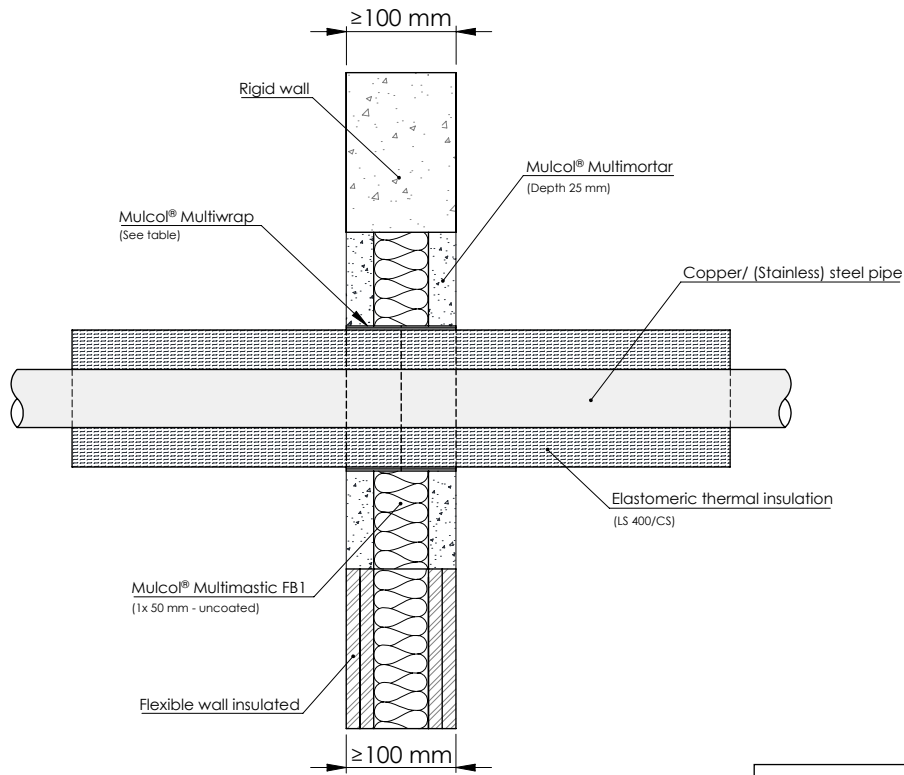
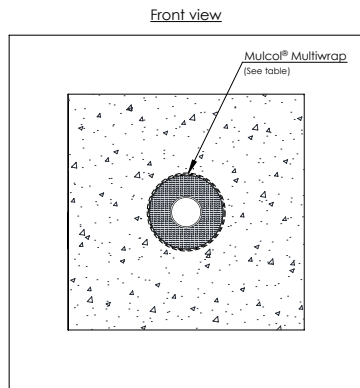

Drawing: FW.E-CU-MW2-MM3.4.22

Services	Pipe dimensions (mm)		Insulation			Product	Classification
	Outer dimension	Wall thickness	Type	Thickness (mm)	Configuration		
Copper / (stainless) steel / cast iron	$\leq \text{Ø } 12$	≥ 1.0	ArmaFlex (min. class B-s3, d0 B _L -s3, d0)	9	LS 400 / CS	Multiwrap (2 layers)	EI 120 C/U, E 180 C/U
	$\leq \text{Ø } 35$	≥ 1.1		35			EI 90 C/U, E 120 C/U
	$\leq \text{Ø } 54$	≥ 1.5		60			EI 120 C/U
(Stainless) Steel / cast iron	$\leq \text{Ø } 114.3$	≥ 3.6		38	CS		EI 60 C/U, E 120 C/U
	$\leq \text{Ø } 219.1$	≥ 4.0		15			EI 45 C/U, E 120 C/U
	$\leq \text{Ø } 324$	≥ 3.7		50	32		LS 400 / CS
			CS		Multiwrap (3 layers)	EI 60 C/U, E 120 C/U	
				CS	Multiwrap (3 layers)	EI 45 C/U, E 180 C/U	
						EI 90 C/U, E 180 C/U	

A.1.8 Multimortar 25 mm + Multimastic FB 50 mm + Multimortar 25 mm - ≥ 100 mm - Metal pipes insulated elastomer
A.1.8.1 Copper and steel pipes - Elastomer LS 400 / CS

Services	Pipe dimensions (mm)		Insulation			Product	Classification
	Outer dimension	Wall thickness	Type	Thickness (mm)	Configuration		
Copper / (stainless) steel / cast iron	$\leq \varnothing 22$	≥ 1.0	Kaiflex ST (min. class B-s3, d0 B _L -s3, d0)	9 - 32	LS 400 / CS	Multiwrap (2 layers)	EI 90 C/U, E 120 C/U
				32			EI 120 C/U
	$\leq \varnothing 54$	≥ 1.5		13 - 32			EI 30 C/U, E 120 C/U
				32			EI 60 C/U, E 120 C/U
(Stainless) Steel / cast iron	$\leq \varnothing 114.3$	≥ 3.6		13			EI 45 C/U, E 120 C/U
				13 - 32			EI 60 C/U, E 120 C/U
	$\leq \varnothing 168.3$	≥ 4.5	32	EI 60 C/U, E 120 C/U			

A.1.9 Multimortar 100 mm - ≥ 100 mm - Metal pipes insulated elastomer

A.1.9.1 Copper and steel pipes - Elastomer LS 400 / CS

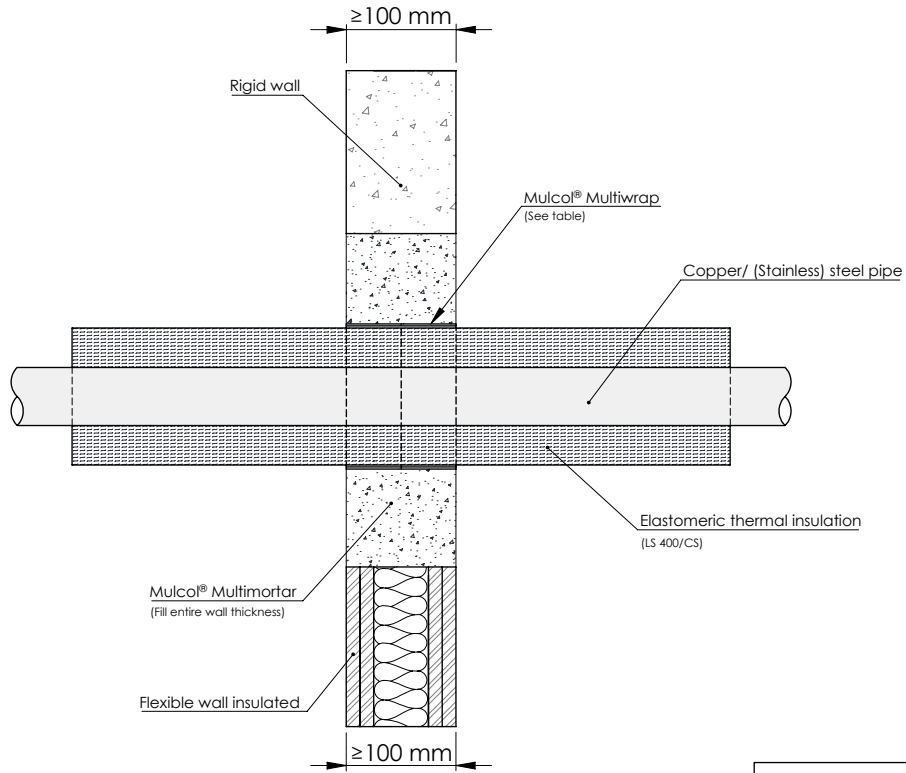
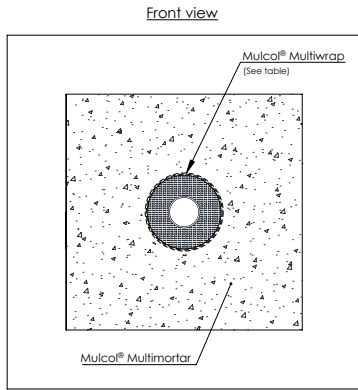

Drawing: FW.E-CU-MW2-MM1.2.22

Services	Pipe dimensions (mm)		Insulation			Product	Classification
	Outer dimension	Wall thickness	Type	Thickness (mm)	Configuration		
Copper / (stainless) steel / cast iron	≤ Ø 12	≥ 1.0	ArmaFlex AF (min. class B-s3, d0 B _L -s3, d0)	9	LS 400 / CS	Multiwrap (2 layers)	EI 120 C/U, E 180 C/U
	≤ Ø 35	≥ 1.1		35			EI 90 C/U, E 120 C/U
	≤ Ø 54	≥ 1.5		60			EI 120 C/U
(Stainless) Steel / cast iron	≤ Ø 114.3	≥ 3.6		38	CS		EI 60 C/U, E 120 C/U
	≤ Ø 219.1	≥ 4.0		15			EI 45 C/U, E 120 C/U
	≤ Ø 324	≥ 3.7		32	LS 400 / CS		EI 120 C/U
			50	CS	Multiwrap (3 layers)	EI 60 C/U, E 120 C/U	
						EI 45 C/U, E 180 C/U	
						EI 90 C/U, E 180 C/U	

A.1.9 Multimortar - ≥ 100 mm - Metal pipes insulated elastomer

A.1.9.1 Copper and steel pipes - Elastomer LS 400 / CS

Services	Pipe dimensions (mm)		Insulation			Product	Classification
	Outer dimension	Wall thickness	Type	Thickness (mm)	Configuration		
Copper / (stainless-) steel / cast iron	$\leq \varnothing 22$	≥ 1.0	Kaiflex ST (min. class B-s3, d0 B _L -s3, d0)	9 - 32	LS 400 / CS	Multiwrap (2 layers)	EI 90 C/U, E 120 C/U
				32			EI 120 C/U
	$\leq \varnothing 54$	≥ 1.5		13 - 32			EI 30 C/U, E 120 C/U
				32			EI 60 C/U, E 120 C/U
(Stainless) Steel / cast iron	$\leq \varnothing 114.3$	≥ 3.6		13			EI 45 C/U, E 120 C/U
	$\leq \varnothing 168.3$	≥ 4.5		13 - 32			EI 60 C/U, E 120 C/U
			32	EI 60 C/U, E 120 C/U			

A.1.10 Direct through wall - Metal pipes insulated elastomer

A.1.10.1 Copper and steel pipes - Elastomer LS 400 / CS

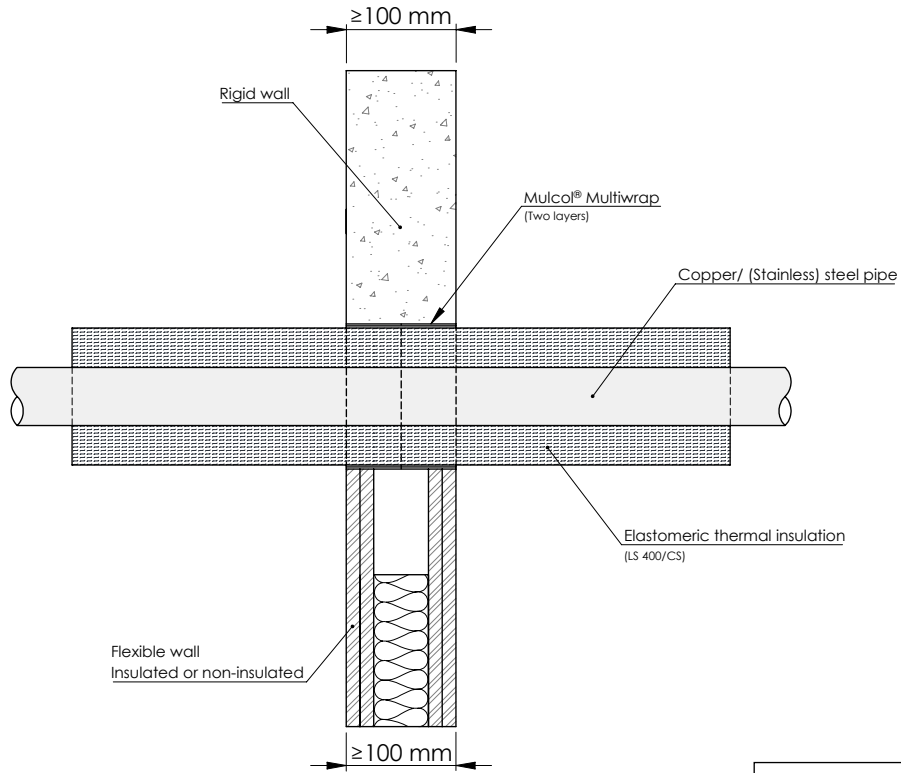
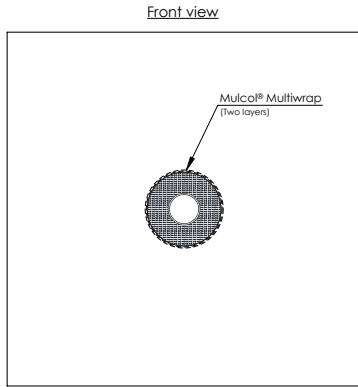

Drawing: FW-CU-MW2.1.2

Services	Pipe dimensions (mm)		Insulation			Product	Classification
	Outer dimension	Wall thickness	Type	Thickness (mm)	Configuration		
Copper / (stainless) steel / cast iron	≤ Ø 12	≥ 1.0	ArmaFlex AF (min. class B-s3, d0 B _L -s3, d0)	9	LS 400 / CS	Multiwrap (2 layers)	EI 120 C/U, E 180 C/U
	≤ Ø 35	≥ 1.1		35			EI 90 C/U, E 120 C/U
	≤ Ø 54	≥ 1.5		60			EI 120 C/U
(Stainless) Steel / cast iron	≤ Ø 114.3	≥ 3.6		38	CS		EI 60 C/U, E 120 C/U
	≤ Ø 219.1	≥ 4.0		15			EI 45 C/U, E 120 C/U
	≤ Ø 324	≥ 3.7		50	32		LS 400 / CS
			CS		Multiwrap (3 layers)	EI 60 C/U, E 120 C/U	
						EI 45 C/U, E 180 C/U	
						EI 90 C/U, E 180 C/U	

A.1.10 Direct through wall - Metal pipes insulated elastomer

A.1.10.1 Copper and steel pipes - Elastomer LS 400 / CS

Services	Pipe dimensions (mm)		Insulation			Product	Classification
	Outer dimension	Wall thickness	Type	Thickness (mm)	Configuration		
Copper / (stainless-) steel / cast iron	≤ Ø 22	≥ 1.0	Kaiflex ST (min. class B-s3, d0 B _L -s3, d0)	9 - 32	LS 400 / CS	Multiwrap (2 layers)	EI 90 C/U, E 120 C/U
				32			EI 120 C/U
	≤ Ø 54	≥ 1.5		13 - 32			EI 30 C/U, E 120 C/U
				32			EI 60 C/U, E 120 C/U
(Stainless) Steel / cast iron	≤ Ø 114.3	≥ 3.6		13			EI 45 C/U, E 120 C/U
	≤ Ø 168.3	≥ 4.5		13 - 32			EI 60 C/U, E 120 C/U
			32	EI 60 C/U, E 120 C/U			

A.2.1 Multimastic FB2 - 2x 60 mm 30 mm cavity - Combustible pipes

A.2.1.1 Plastic pipes

Front view

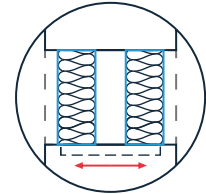
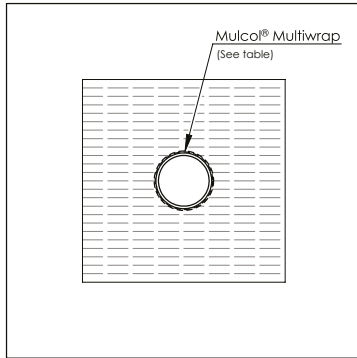

Position seal:
right, left or any in between

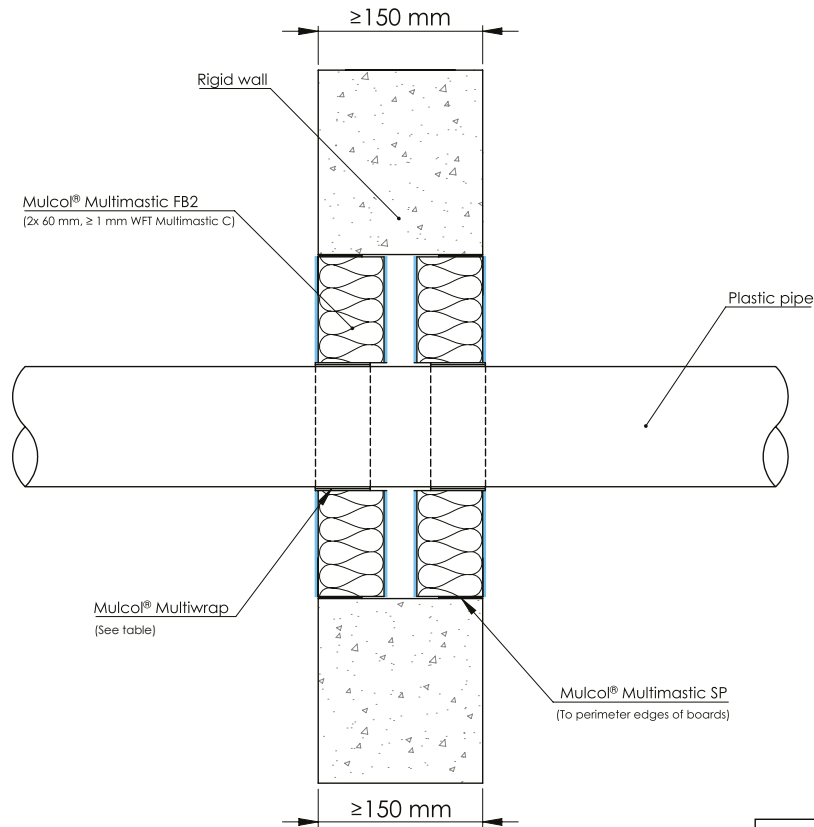

Drawing: RW150.E-PP-MW2-MFB2.2.10

Services	Pipe dimensions (mm)		Product	Classification
	Outer dimension	Wall thickness		
PE(-HD) / PE-X / ABS / SAN+PVC	≤ Ø 40	2.0 to 5.5	Multiwrap (1 layer)	EI 240 U/C
	≤ Ø 110	3.4	Multiwrap (2 layers)	
		≤ Ø 160	4.0 to 9.5	Multiwrap (6 layers)
	9.5			
PP	≤ Ø 40	1.8 to 5.5	Multiwrap (1 layer)	EI 240 U/C
PVC(-U/-C)	≤ Ø 40	2.0 to 5.5	Multiwrap (1 layer)	EI 180 U/C, E 240 U/C
	≤ Ø 110	2.7 to 8.6	Multiwrap (2 layers)	
	≤ Ø 160	4.0 to 11.8	Multiwrap (6 layers)	

A.2.2 Direct through wall - Combustible pipes

A.2.2.1 Plastic pipes

Front view

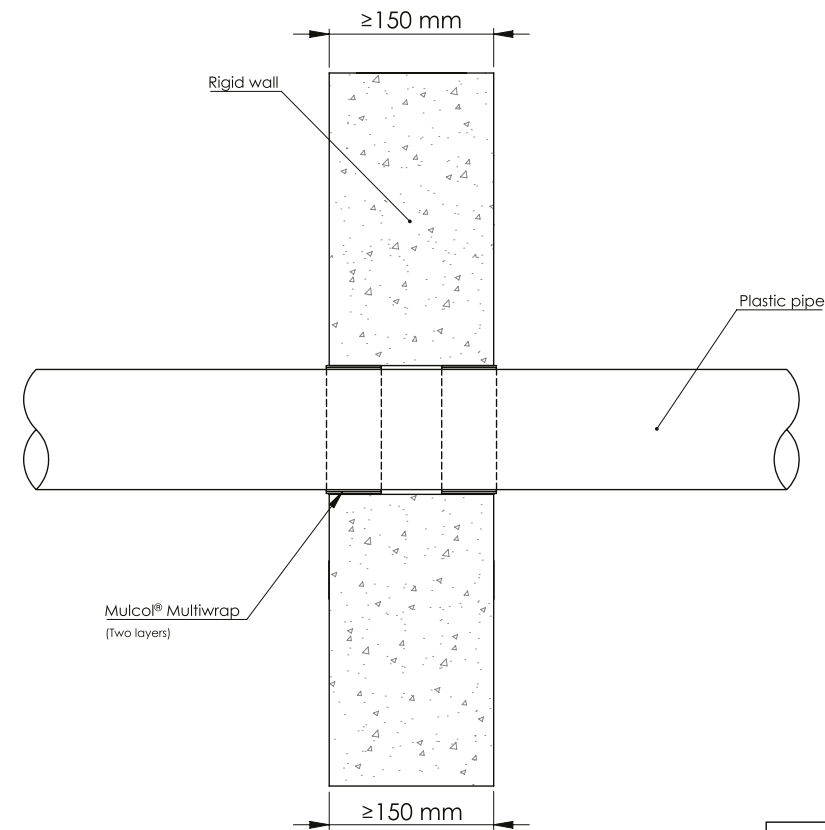
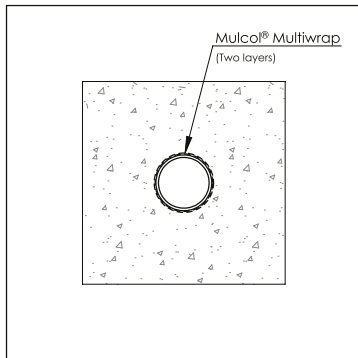

Drawing: RW150-PP-MW2-0.0.10

Services	Pipe dimensions (mm)		Product	Classification
	Outer dimension	Wall thickness		
PE(-HD) / PE-X / ABS / SAN+PVC	$\leq \text{Ø } 40$	2.0 to 5.5	Multiwrap (1 layer)	EI 240 U/C
	$\leq \text{Ø } 110$	3.4	Multiwrap (2 layers)	
		$\leq \text{Ø } 160$	4.0 to 9.5	Multiwrap (6 layers)
	9.5			
PP	$\leq \text{Ø } 40$	1.8 to 5.5	Multiwrap (1 layer)	EI 240 U/C
PVC(-U/-C)	$\leq \text{Ø } 40$	2.0 to 5.5		
	$\leq \text{Ø } 110$	2.7 to 8.6	Multiwrap (2 layers)	EI 180 U/C, E 240 U/C
	$\leq \text{Ø } 160$	4.0 to 11.8	Multiwrap (6 layers)	

B.1.1 Multimortar - ≥ 100 mm - Cables, trays and conduits

B.1.1.1 Plastic pipes with cables

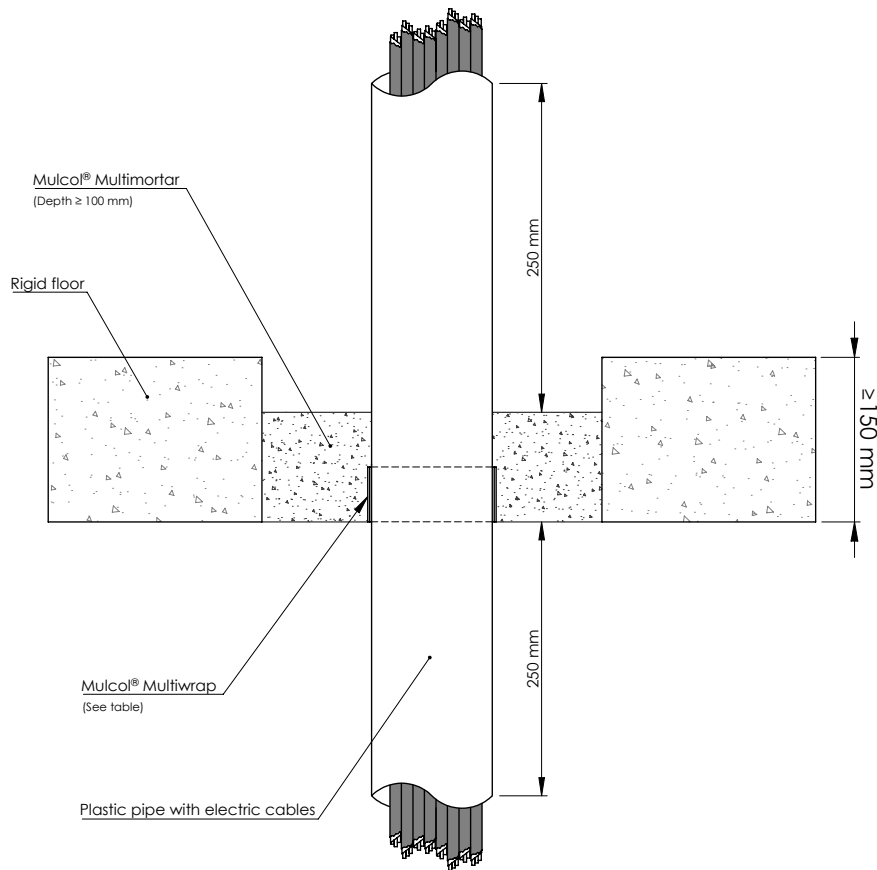
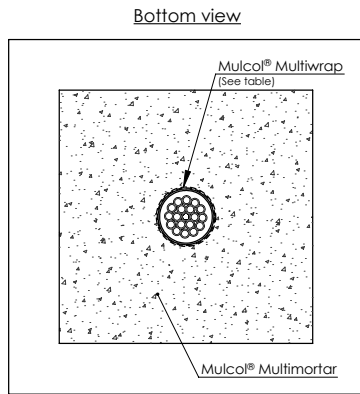

Drawing: RF.E-PPEC-MM1.2.10

Services	Pipe dimensions (mm)		Product	Classification
	Outer dimension	Wall thickness		
PE(-HD) / PE-X / ABS / SAN+PVC	$\leq \text{Ø } 110$	2.7 - 10	Multiwrap (2 layers)	EI 180 U/C
PP				
PVC(-U/-C)				
Cables $\leq \text{Ø } 21$ mm (single or bundled)	-	-	-	EI 180
Cables $\leq \text{Ø } 21$ mm in a tied bundle $\leq \text{Ø } 100$ mm	-	-	-	EI 180
Cables $\leq \text{Ø } 50$ mm	-	-	-	EI 60, E 120

B.1.2 Multimortar - ≥ 150 mm - Cables, trays and conduits

B.1.2.1 Plastic pipes with cables

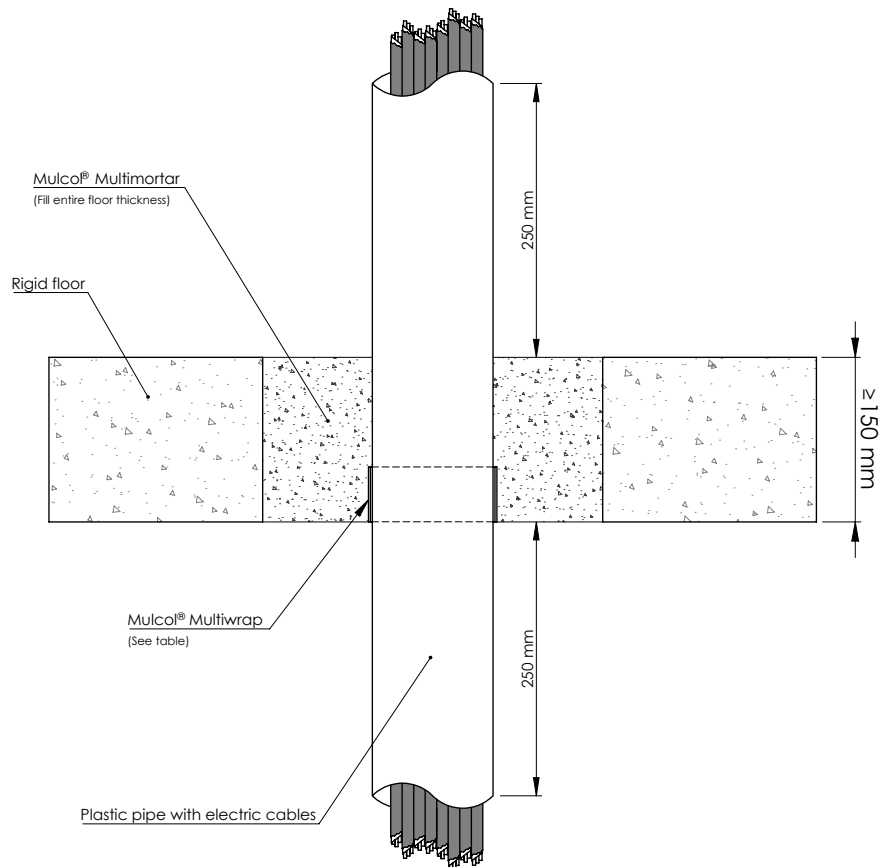
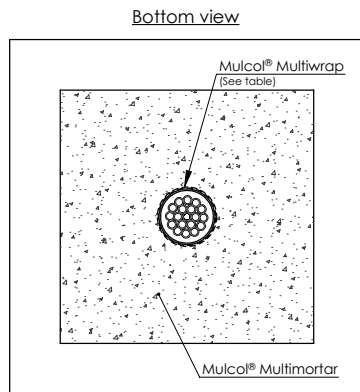

Drawing: RF.E-PPEC-MM1.3.10

Services	Pipe dimensions (mm)		Product	Classification
	Outer dimension	Wall thickness		
PE(-HD) / PE-X / ABS / SAN+PVC	$\leq \text{Ø } 110$	2.7 - 10	Multiwrap (2 layers)	EI 180 U/C
PP				
PVC(-U/-C)				
Cables $\leq \text{Ø } 21$ mm (single or bundled)	-	-	-	EI 180
Cables $\leq \text{Ø } 21$ mm in a tied bundle $\leq \text{Ø } 100$ mm	-	-	-	EI 180
Cables $\leq \text{Ø } 50$ mm	-	-	-	EI 60, E 120

B.1.3 Multimastic FB1 - 2x 50 mm no cavity - Combustible pipes

B.1.3.1 Plastic pipes

Bottom view

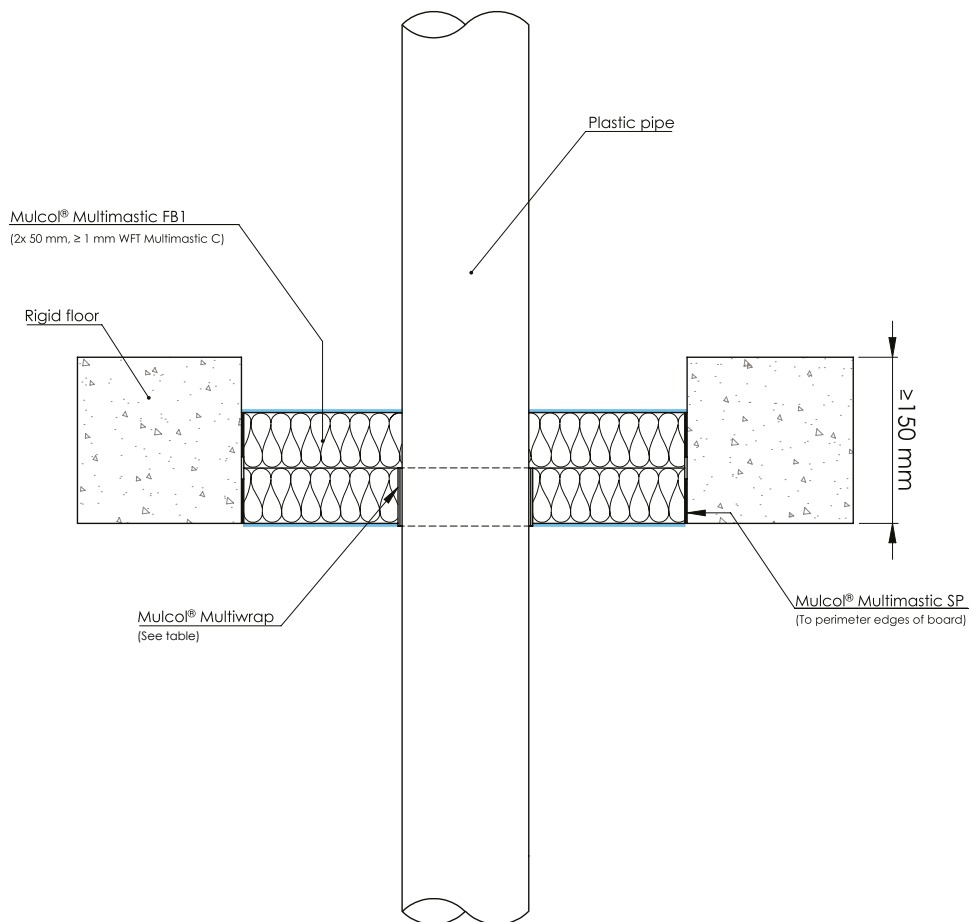
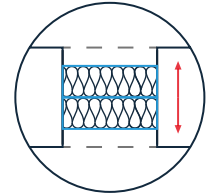
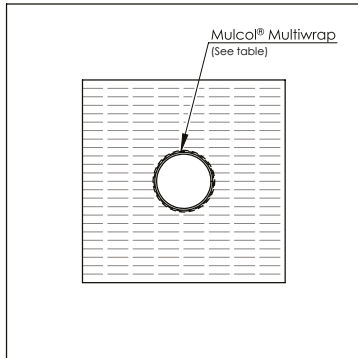

Drawing: PBrf.E-PP-MW2-MFB1.2.10

Services	Pipe dimensions (mm)		Product	Classification
	Outer dimension	Wall thickness		
PVC(-U/-C)	≤ Ø 110	3.2	Multiwrap (2 layers)	EI 120 U/C

B.1.3 Multimastic FB1 - 2x 50 mm no cavity - Combustible pipes

B.1.3.2 Plastic pipes (Silent)

Bottom view

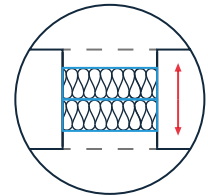
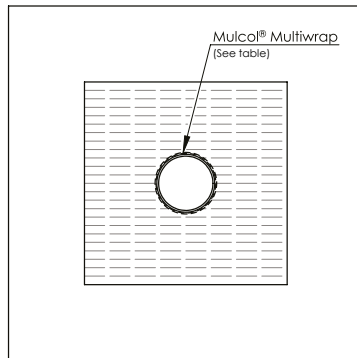

Position seal:
top, bottom or anywhere
in between

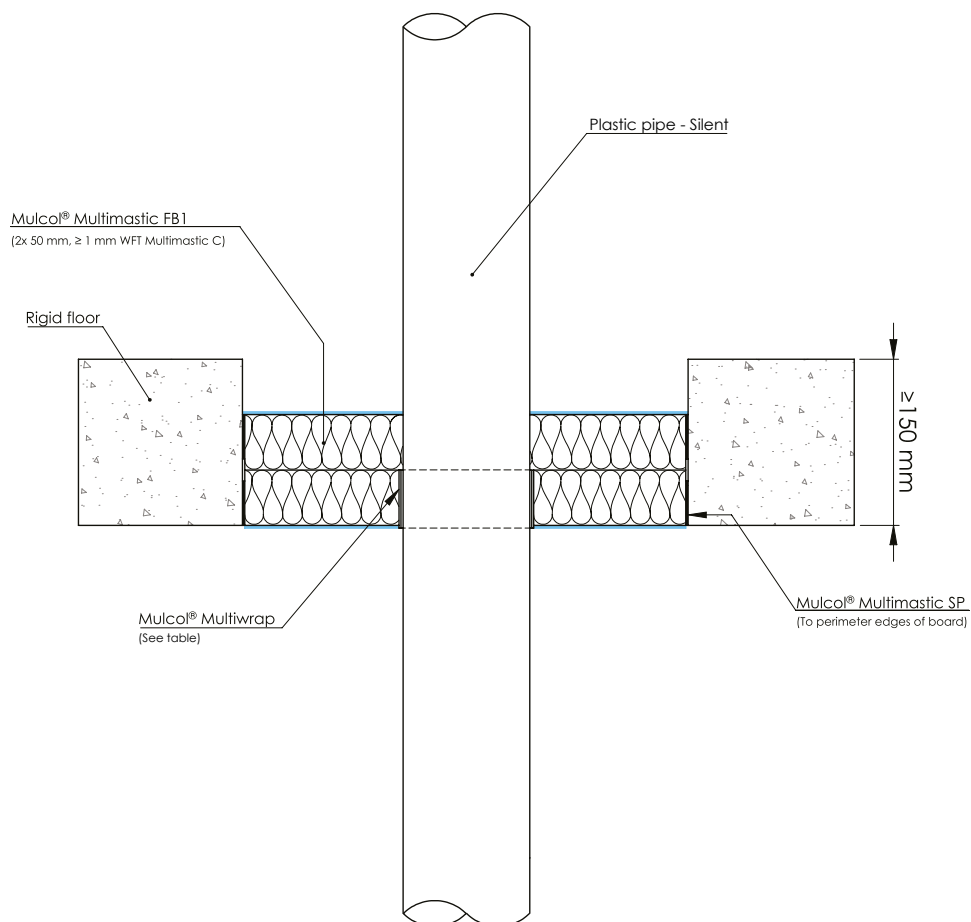

Drawing: PBrf.E-PPS-MW2-MFB1.2.10

Services	Pipe dimensions (mm)		Product	Classification
	Outer dimension	Wall thickness		
Poloplast PoloKal NG	≤ Ø 50	2.0	Multiwrap (2 layers)	EI 240 U/U
	≤ Ø 110	3.4		
Geberit Silent dB20	≤ Ø 56	3.2		
	≤ Ø 110	6.0		EI 240 U/C
Poloplast PoloKal NG	≤ Ø 125	3.9	Multiwrap (4 layers)	

B.1.4 Multimastic FB1 - 2x 50 mm cavity 50 mm - Combustible pipes

B.1.4.1 Plastic pipes

Bottom view

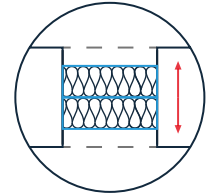
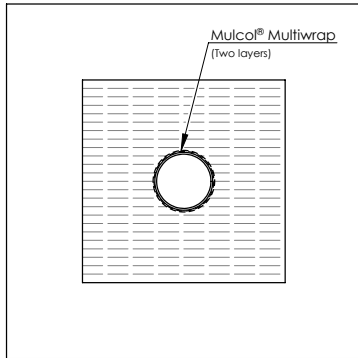

Position seal:
top, bottom or anywhere
in between

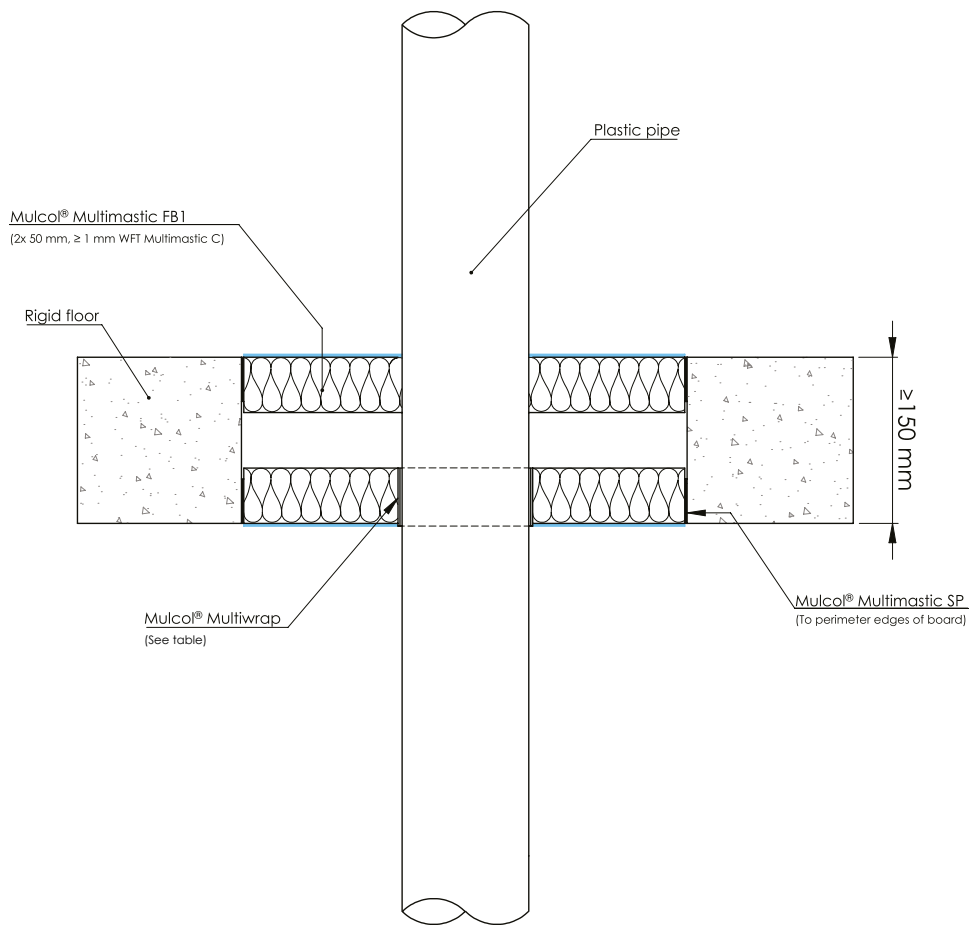

Drawing: PBrf.E-PP-MW2-MFB1.2.10.C

Services	Pipe dimensions (mm)		Product	Classification
	Outer dimension	Wall thickness		
PVC(-U/-C)	≤ Ø 110	3.2	Multiwrap (2 layers)	EI 120 U/C

B.1.4 Multimastic FB1 - 2x 50 mm cavity 50 mm - Combustible pipes

B.1.4.2 Plastic pipes (Silent)

Bottom view

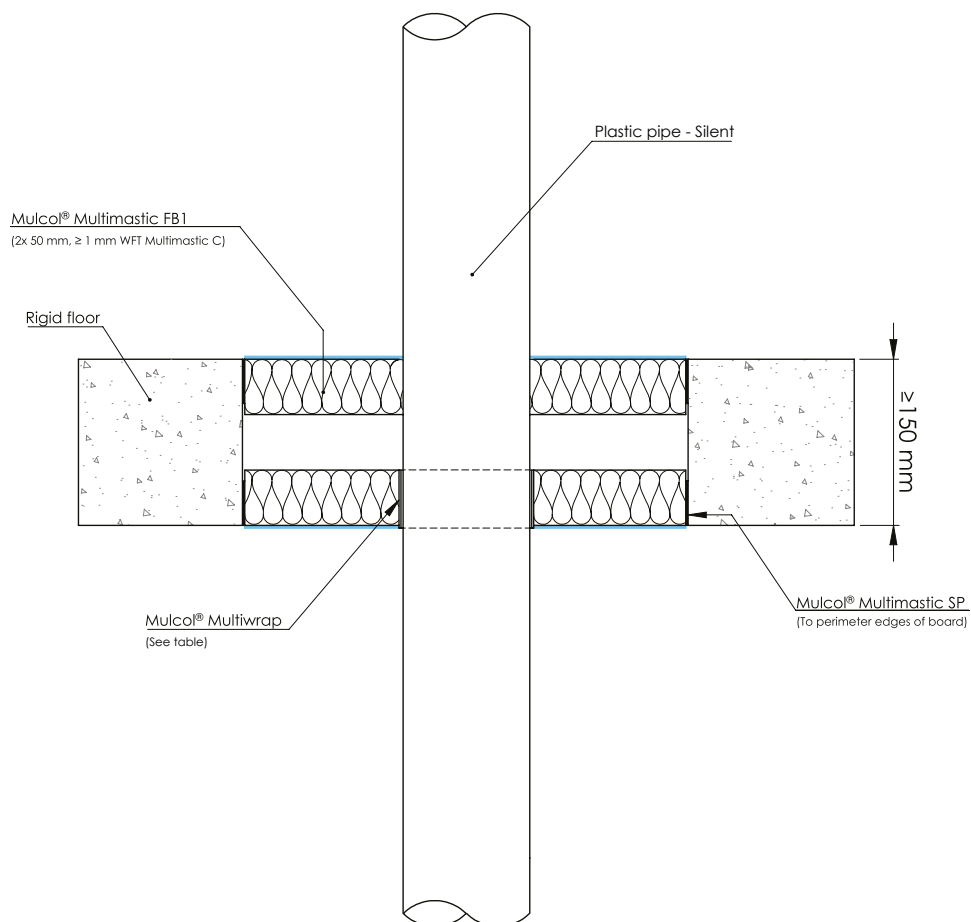
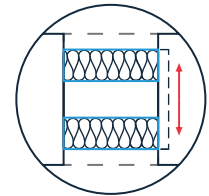
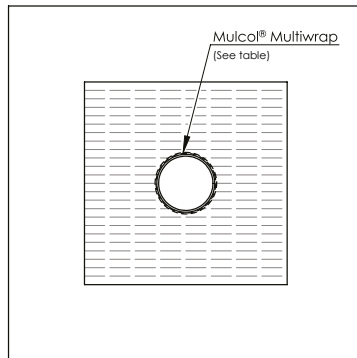

Drawing: PBrf.E-PPS-MW2-MFB1.2.10.C

Services	Pipe dimensions (mm)		Product	Classification	
	Outer dimension	Wall thickness			
Poloplast PoloKal NG	≤ Ø 50	2.0	Multiwrap (2 layers)	EI 240 U/U	
	≤ Ø 110	3.4			
Geberit Silent dB20	≤ Ø 56	3.2		Multiwrap (4 layers)	EI 240 U/C
	≤ Ø 110	6.0			
Poloplast PoloKal NG	≤ Ø 125	3.9			

B.1.5 Multimastic FB2 - 1x 60 mm - Combustible pipes

B.1.5.1 Plastic pipes

Bottom view

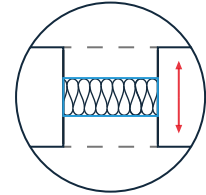
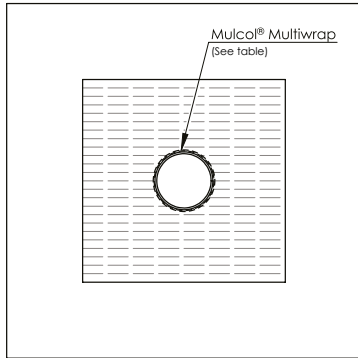

Position seal:
top, bottom or anywhere
in between

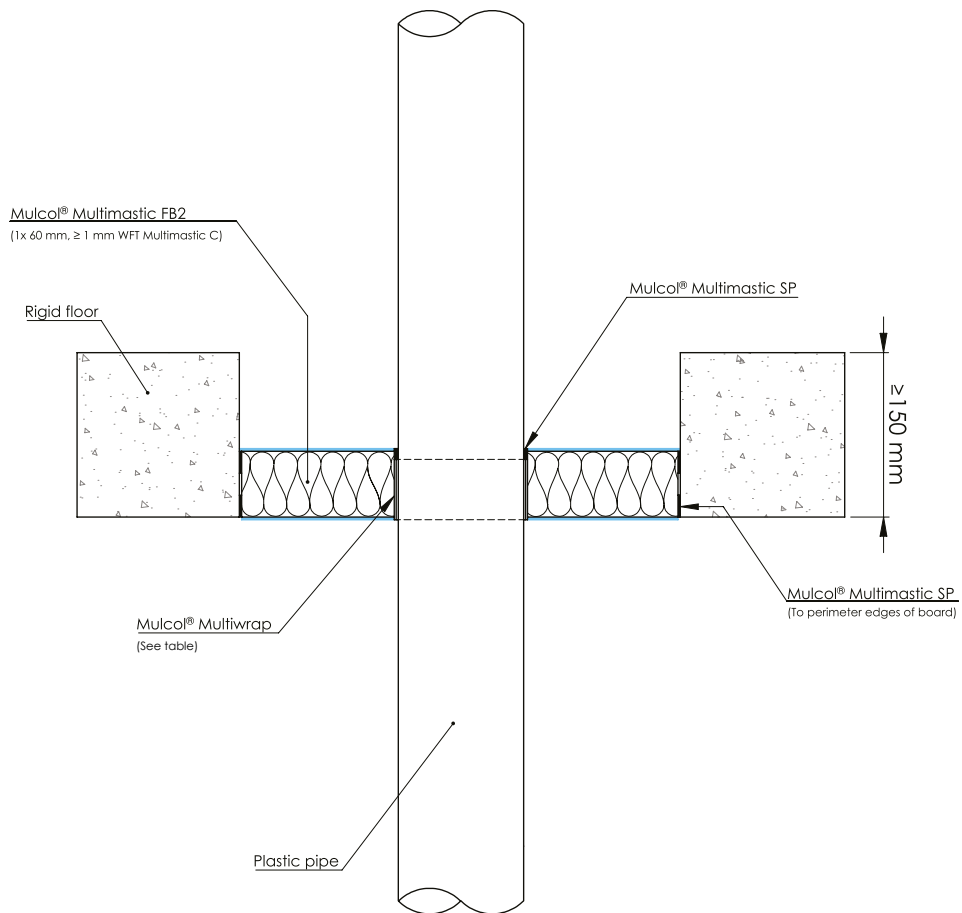

Drawing: PBrf.E-PP-MW2-MFB2.1.10

Services	Pipe dimensions (mm)		Product	Sealing (mm)	Classification
	Outer dimension	Wall thickness			
PVC(-U/-C)	≤ Ø 110	3.2	Multiwrap (2 layers)	Multimastic SP 0-20 x ≥ 5 (wxd) top of floor	EI 120 U/C

B.1.6 Multimortar - ≥ 100 mm - Combustible pipes

B.1.6.1 Plastic pipes

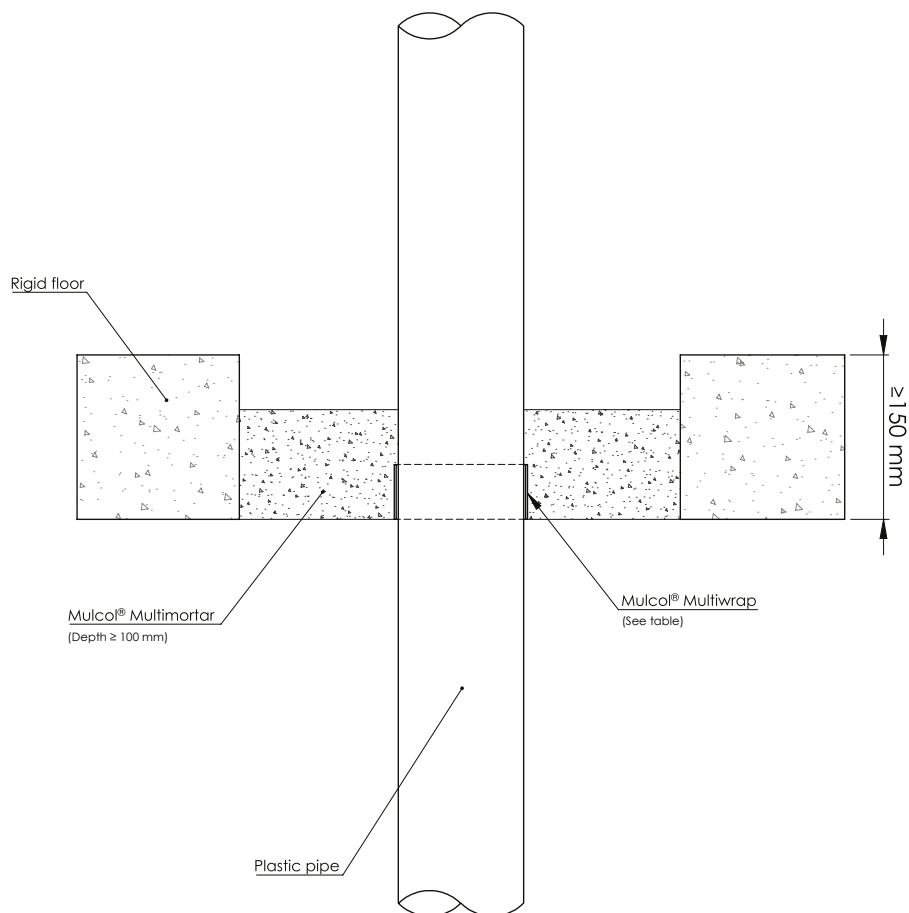
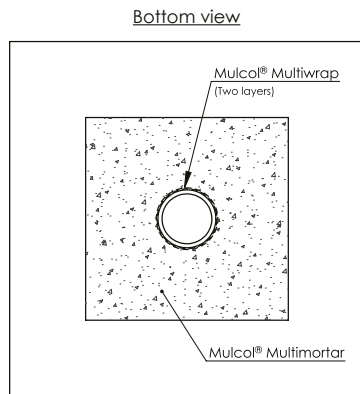

Drawing: PBrf.E-PP-MW2-MFB2.1.10

Services	Pipe dimensions (mm)		Product	Classification	
	Outer dimension	Wall thickness			
PE-HD / PE-X / ABS / SAN+PVC	$\leq \varnothing 40$	2.0 - 3.7	Multiwrap (1 layer)	EI 240 U/U	
PP		1.8 - 5.5			
PVC(-U/-C)		2.0 - 3.7			
PE-HD / PE-X / ABS / SAN+PVC	$\leq \varnothing 50$	3.0 - 4.6		Multiwrap (2 layers)	EI 180 U/C
PP		2.9 - 4.6			
PVC(-U/-C)		3.0 - 4.6			
PE-HD / PE-X / ABS / SAN+PVC	$\leq \varnothing 110$	3.4 - 10.0	Multiwrap (2 layers)		EI 240 U/C
PP		2.7 - 6.3			
PVC(-U/-C)		3.4 - 6.3			

B.1.6 Multimortar - ≥ 100 mm - Combustible pipes**B.1.6.1 Plastic pipes**

Services	Pipe dimensions (mm)		Product	Classification
	Outer dimension	Wall thickness		
PE-HD / PE-X / ABS / SAN+PVC	$\leq \varnothing 125$	3.9 - 11.4	Multiwrap (3 layers)	EI 180 U/C
PP		4.8		
PVC(-U/-C)		4.8 - 11.4		EI 120 U/C
PE-HD / PE-X / ABS / SAN+PVC	$\leq \varnothing 110$	2.7	Multiwrap (4 layers)	EI 120 U/U
	$\leq \varnothing 125$	3.9		EI 240 U/U
	$\leq \varnothing 160$	4.9		EI 180 U/C
		4.9 - 14.6		EI 120 U/C
PP	$\leq \varnothing 110$	10.0		EI 240 U/U
	$\leq \varnothing 125$	3.1 - 11.4		EI 240 U/C
		11.4		EI 240 U/U
	$\leq \varnothing 160$	6.2		EI 180 U/C
6.2 - 14.6		EI 90 U/C		
PVC(-U/-C)	$\leq \varnothing 160$	6.2		EI 120 U/C
		6.2 - 14.6	EI 90 U/C	
PE-HD / PE-X / ABS / SAN+PVC	$\leq \varnothing 160$	9.5	Multiwrap (4 layers) (both sides)	EI 240 U/U
PP	$\leq \varnothing 160$	14.6	Multiwrap (6 layers)	EI 120 U/C

B.1.6 Multimortar - ≥ 100 mm - Combustible pipes

B.1.6.2 Plastic pipes (Silent)

Bottom view

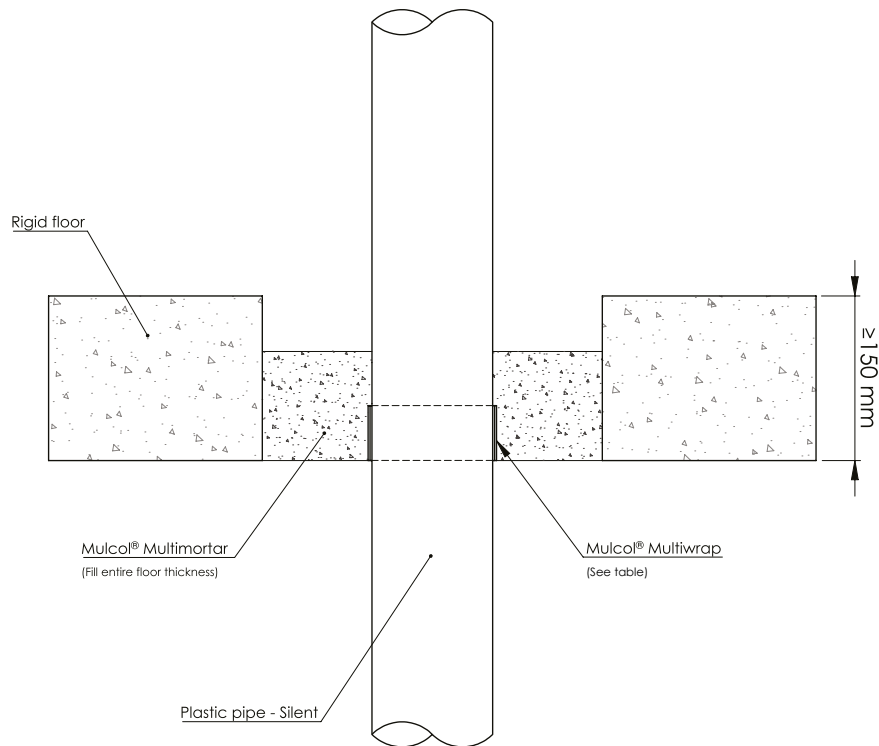
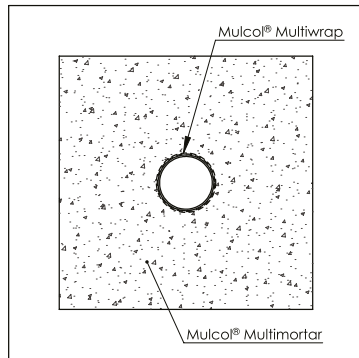

Drawing: RF.E-PPS-MM1.2.10

Services	Pipe dimensions (mm)		Product	Classification
	Outer dimension	Wall thickness		
Rehau Raupiano Plus	$\leq \text{Ø } 50$	1.8	Multiwrap (1 layer)	EI 180 U/C
Wavin SiTech+				
Rehau Raupiano Plus				
Wavin SiTech+				
Poloplast PoloKal NG	$\leq \text{Ø } 56$	2.0	Multiwrap (2 layers)	EI 240 U/U
Geberit Silent dB 20		3.2		
Rehau Raupiano Plus		2.7		
Wavin SiTech+	$\leq \text{Ø } 110$	3.4	Multiwrap (2 layers)	EI 180 U/C
Poloplast PoloKal NG				
Geberit Silent dB 20				
Geberit Silent dB 20				
Geberit Silent dB 20		6.0		EI 240 U/C

B.1.6 Multimortar - ≥ 100 mm - Combustible pipes**B.1.6.2 Plastic pipes (Silent)**

Services	Pipe dimensions (mm)		Product	Classification
	Outer dimension	Wall thickness		
Poloplast PoloKal NG	$\leq \text{Ø } 125$	3.9	Multiwrap (4 layers)	EI 240 U/C
Rehau Raupiano Plus	$\leq \text{Ø } 160$			4.9
Wavin SiTech+		EI 240 U/C		
Poloplast PoloKal NG				

B.1.7 Multimortar - ≥ 150 mm - Combustible pipes

B.1.7.1 Plastic pipes

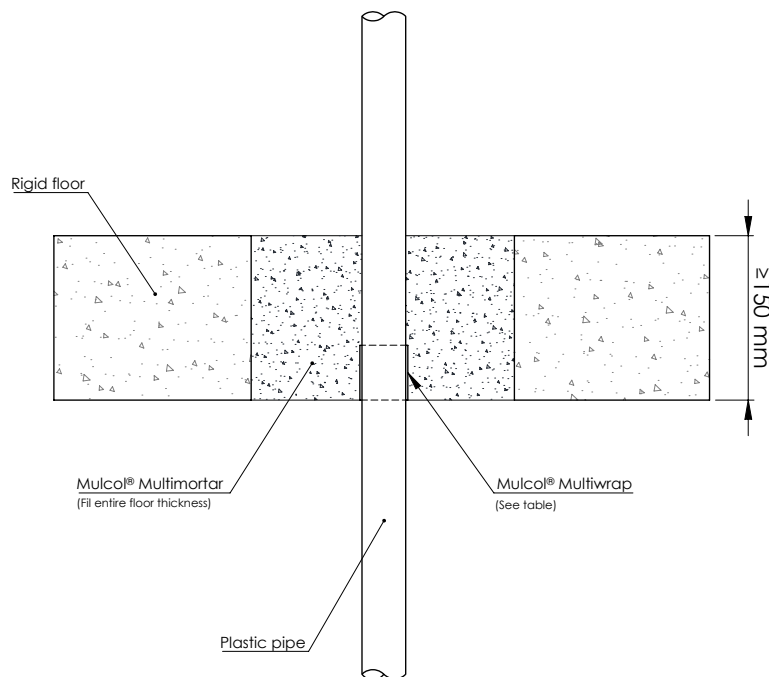
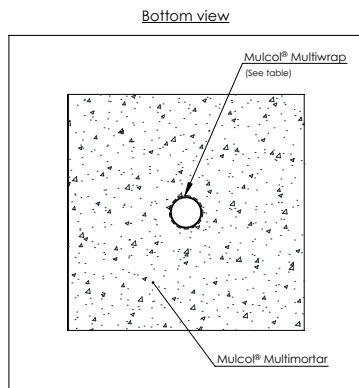

Drawing: RF.E-PP-MW-MM1.3.10

Services	Pipe dimensions (mm)		Product	Classification	
	Outer dimension	Wall thickness			
PE-HD / PE-X / ABS / SAN+PVC	$\leq \text{Ø } 40$	2.0 - 3.7	Multiwrap (1 layer)	EI 240 U/U	
PP		1.8 - 5.5			
PVC(-U/-C)		2.0 - 3.7			
PE-HD / PE-X / ABS / SAN+PVC	$\leq \text{Ø } 50$	3.0 - 4.6		Multiwrap (2 layers)	EI 180 U/ C
PP		2.9 - 4.6			
PVC(-U/-C)		3.0 - 4.6			
PE-HD / PE-X / ABS / SAN+PVC	$\leq \text{Ø } 110$	3.4 - 10.0	EI 240 U/C		
PP		2.7 - 6.3			
PVC(-U/-C)		3.4 - 6.3			

B.1.7 Multimortar - ≥ 150 mm - Cables, trays and conduits**B.1.7.1 Plastic pipes**

Services	Pipe dimensions (mm)		Product	Classification
	Outer dimension	Wall thickness		
PE-HD / PE-X / ABS / SAN+PVC	$\leq \varnothing 125$	3.9 - 11.4	Multiwrap (3 layers)	EI 180 U/C
PP		4.8		
PVC(-U/-C)		4.8 - 11.4		EI 120 U/C
PE-HD / PE-X / ABS / SAN+PVC	$\leq \varnothing 110$	2.7	Multiwrap (4 layers)	EI 120 U/U
	$\leq \varnothing 125$	3.9		EI 240 U/U
	$\leq \varnothing 160$	4.9		EI 180 U/C
		4.9 - 14.6		EI 120 U/C
PP	$\leq \varnothing 110$	10.0		EI 240 U/U
	$\leq \varnothing 125$	3.1 - 11.4		EI 240 U/C
		11.4		EI 240 U/U
	$\leq \varnothing 160$	6.2		EI 180 U/C
6.2 - 14.6		EI 90 U/C		
PVC(-U/-C)	$\leq \varnothing 160$	6.2		EI 120 U/C
		6.2 - 14.6	EI 90 U/C	
PE-HD / PE-X / ABS / SAN+PVC	$\leq \varnothing 160$	9.5	Multiwrap (4 layers) (both sides)	EI 240 U/U
PP	$\leq \varnothing 160$	14.6	Multiwrap (6 layers)	EI 120 U/C

B.1.7 Multimortar - ≥ 150 mm - Combustible pipes

B.1.7.2 Plastic pipes (Silent)

Bottom view

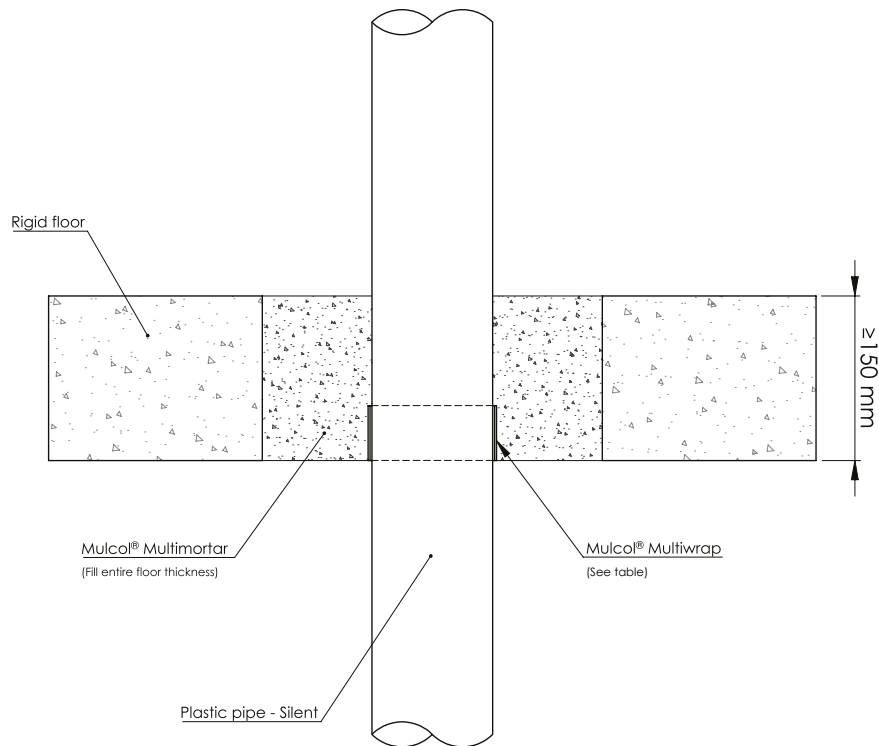
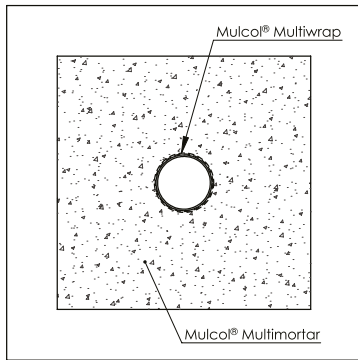

Drawing: RF.E-PPS-MM1.3.10

Services	Pipe dimensions (mm)		Product	Classification
	Outer dimension	Wall thickness		
Rehau Raupiano Plus	$\leq \text{Ø } 50$	1.8	Multiwrap (1 layer)	EI 180 U/C
Wavin SiTech+				
Rehau Raupiano Plus				
Wavin SiTech+				
Poloplast PoloKal NG	$\leq \text{Ø } 56$	2.0	Multiwrap (2 layers)	EI 240 U/U
Geberit Silent dB 20		3.2		
Rehau Raupiano Plus		2.7		
Wavin SiTech+		3.4		
Poloplast PoloKal NG	$\leq \text{Ø } 110$	6.0		EI 240 U/U
Geberit Silent dB 20				EI 240 U/C

B.1.7 Multimortar - ≥ 150 mm - Combustible pipes**B.1.7.2 Plastic pipes (Silent)**

Services	Pipe dimensions (mm)		Product	Classification
	Outer dimension	Wall thickness		
Poloplast PoloKal NG	$\leq \text{Ø } 125$	3.9	Multiwrap (4 layers)	EI 240 U/C
Rehau Raupiano Plus	$\leq \text{Ø } 160$			4.9
Wavin SiTech+		EI 240 U/C		
Poloplast PoloKal NG				

B.1.8 Multimortar + Multimastic FB - ≥ 100 mm - Combustible pipes

B.1.8.1 Plastic pipes

Bottom view

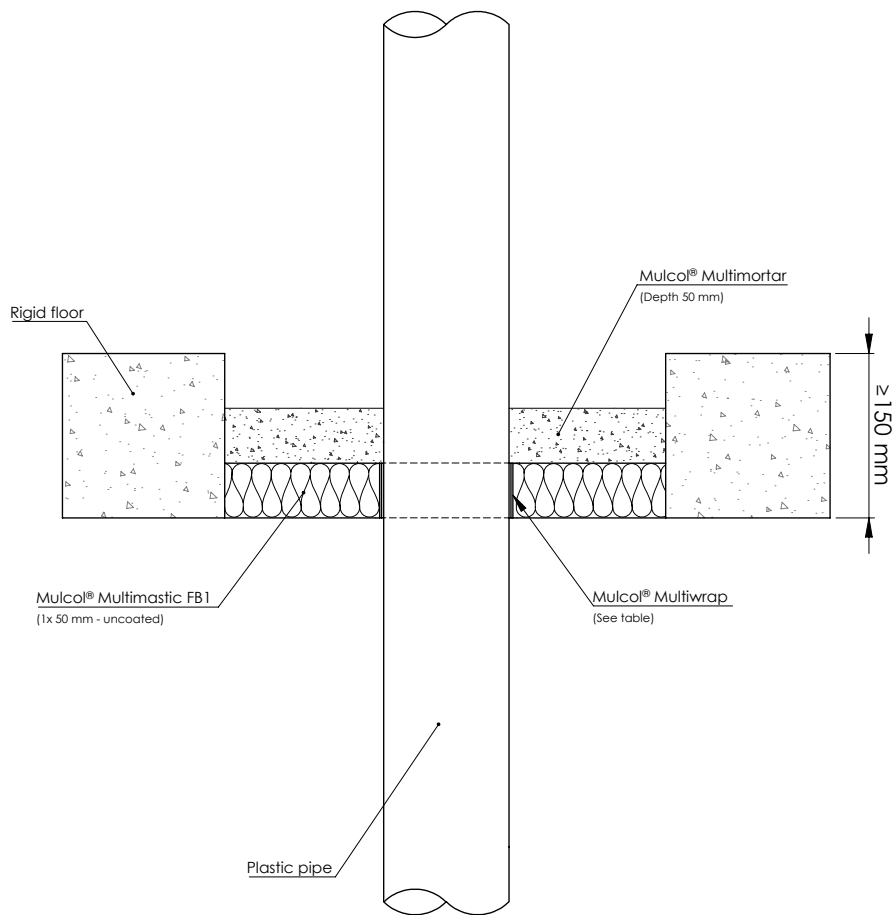
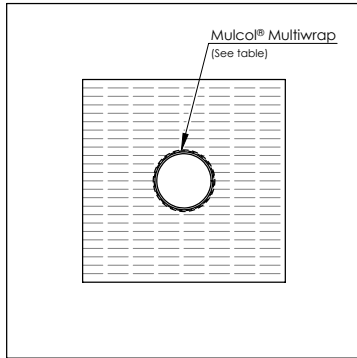

Drawing: RF.E-PP-MW-MM2.5.10

Services	Pipe dimensions (mm)		Product	Classification
	Outer dimension	Wall thickness		
PVC(-U/-C)	$\leq \text{Ø } 110$	3.2	Multiwrap (2 layers)	EI 120 U/C
PP		10.0	Multiwrap (4 layers)	EI 180 U/U

B.1.8 Multimortar + Multimastic FB - ≥ 100 mm - Combustible pipes

B.1.8.2 Plastic pipes (Silent)

Bottom view

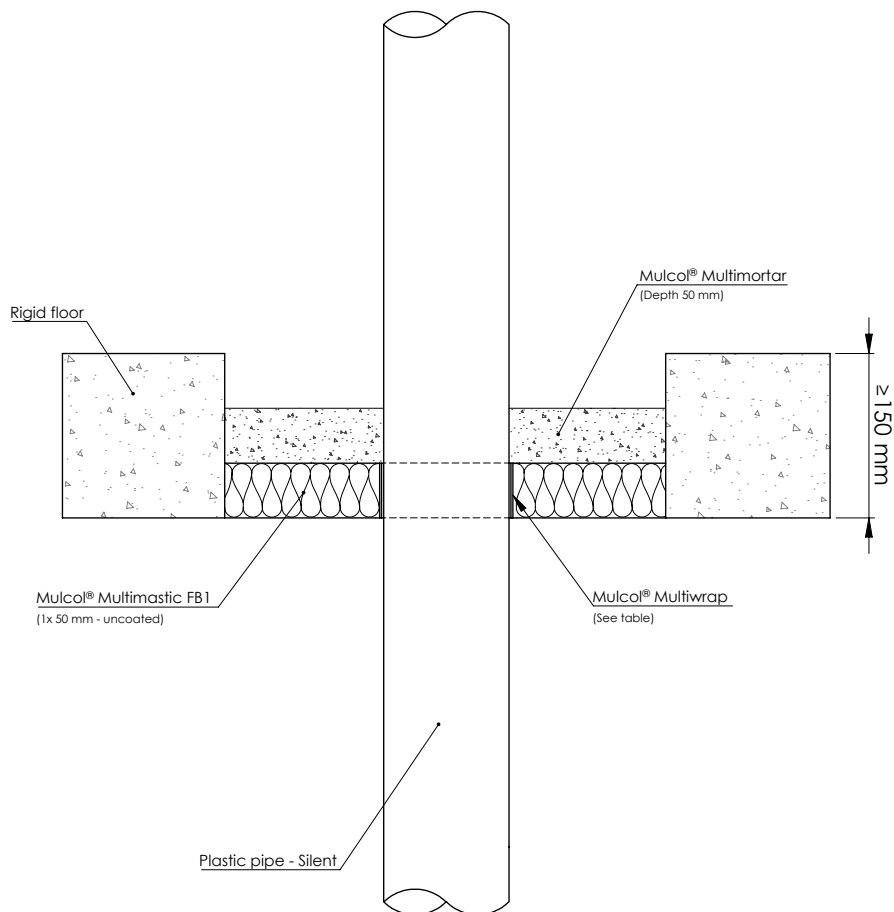
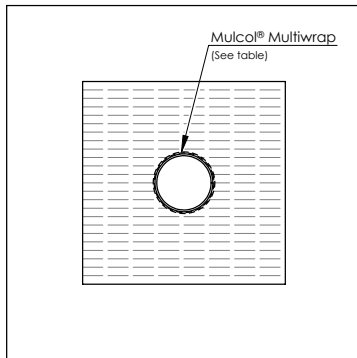

Drawing: RF,E-PPS-MW-MM2.5.10

Services	Pipe dimensions (mm)		Product	Classification
	Outer dimension	Wall thickness		
Poloplast PoloKal NG	$\leq \text{Ø } 50$	2.0	Multiwrap (2 layers)	EI 180 U/U
Geberit Silent dB 20	$\leq \text{Ø } 56$	3.2		
Poloplast PoloKal NG	$\leq \text{Ø } 110$	3.4		
Geberit Silent dB 20		6.0		
Poloplast PoloKal NG	$\leq \text{Ø } 125$	3.9	Multiwrap (4 layers)	EI 180 U/C

B.1.9 Multimortar + Multimastic FB - ≥ 150 mm - Combustible pipes

B.1.9.1 Plastic pipes

Bottom view

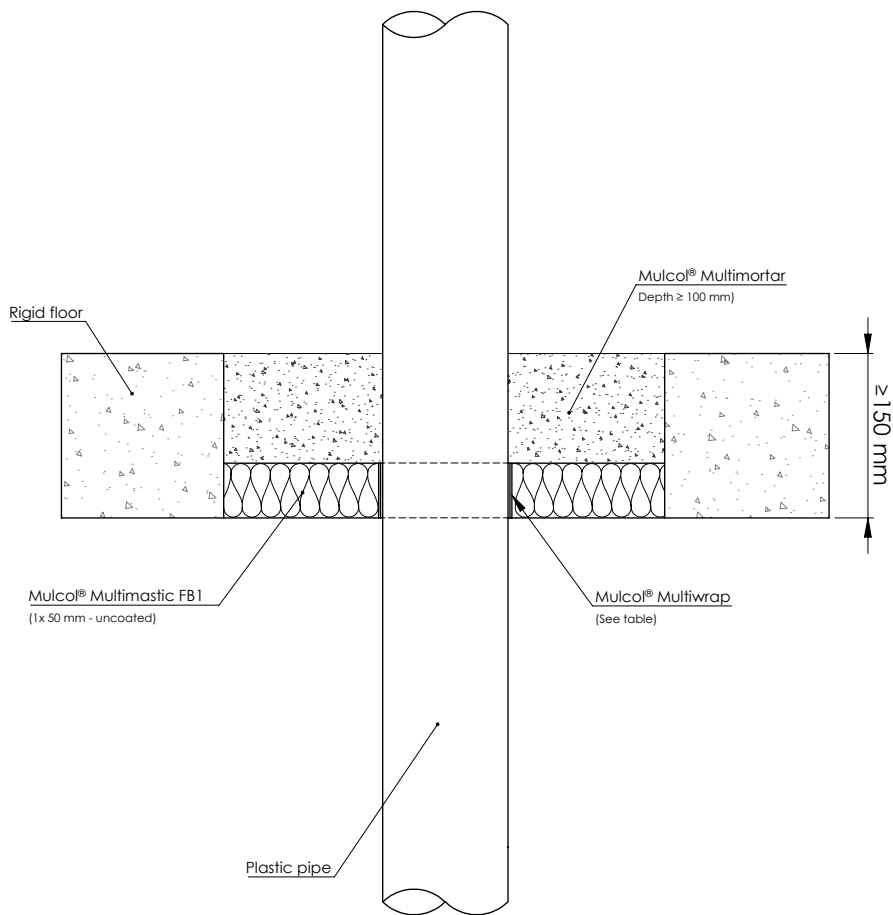
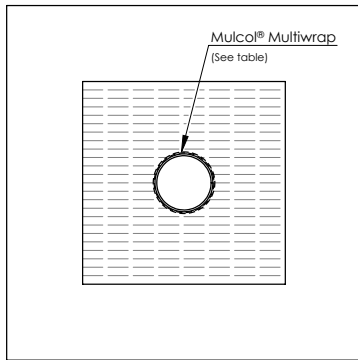

Drawing: RF.E-PP-MW-MM2.7.10

Services	Pipe dimensions (mm)		Product	Classification
	Outer dimension	Wall thickness		
PVC(-U/-C)	$\leq \text{Ø } 110$	3.2	Multiwrap (2 layers)	EI 120 U/C
PP		10.0	Multiwrap (4 layers)	EI 240 U/U
PE-HD / PE-X / ABS / SAN+PVC		2.7		EI 120 U/U

B.1.9 Multimortar + Multimastic FB - ≥ 150 mm - Combustible pipes

B.1.9.2 Plastic pipes (Silent)

Bottom view

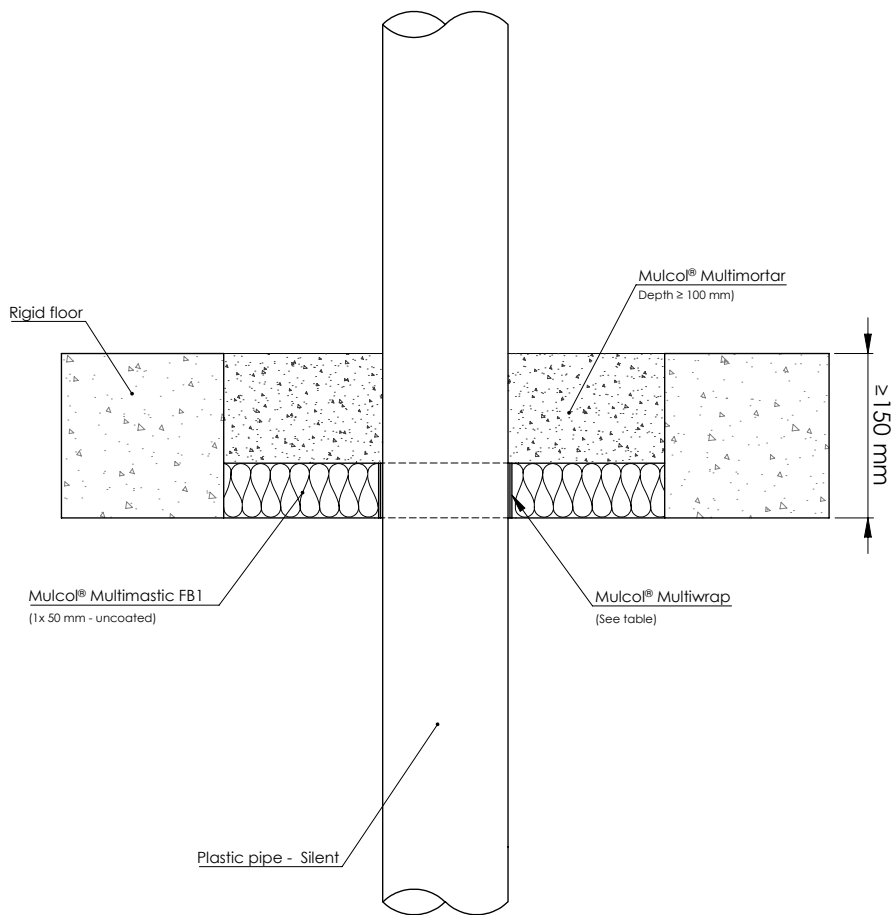
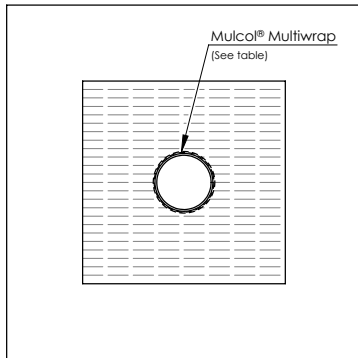

Drawing: RF,E-PPS-MW-MM2.7.10

Services	Pipe dimensions (mm)		Product	Classification
	Outer dimension	Wall thickness		
Poloplast PoloKal NG	$\leq \text{Ø } 50$	2.0	Multiwrap (2 layers)	EI 240 U/U
Geberit Silent dB 20	$\leq \text{Ø } 56$	3.2		
Poloplast PoloKal NG	$\leq \text{Ø } 110$	3.4		
Geberit Silent dB 20		6.0		
Poloplast PoloKal NG	$\leq \text{Ø } 125$	3.9	Multiwrap (4 layers)	EI 240 U/C

B.1.10 Multimastic FB1 - 2x 50 mm no cavity - Metal pipes insulated elastomer

B.1.10.1 Copper and steel pipes - Elastomer LS 400 / CS

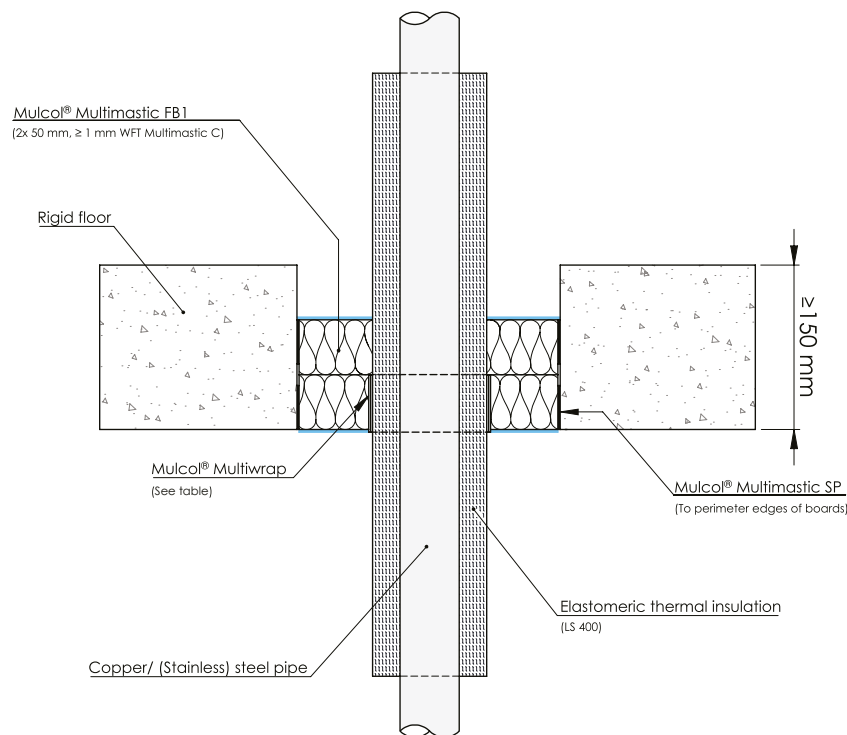
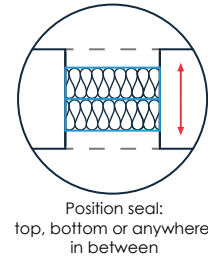
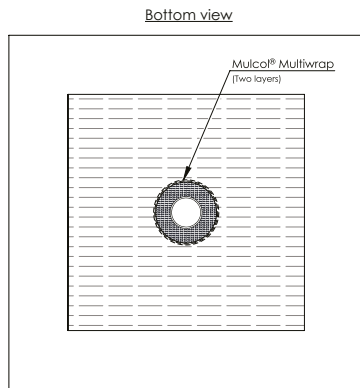

Drawing: PBrf.E-CU-MW2-MFB1.2.22

Services	Pipe dimensions (mm)		Insulation			Product	Sealing (mm)	Classification
	Outer dimension	Wall thickness	Type	Thickness (mm)	Configuration			
Copper / (stainless) steel / cast iron	≤ Ø 12	≥ 1	ArmaFlex AF (min. class B-s3, d0 B _L -s3, d0)	11	LS 400 / CS	Multiwrap (2 layers)	Multimastic SP 0-20 x ≥ 5 (wxd) top of floor	EI 120 C/U
				E 240 C/U				
Copper / (stainless) steel / cast iron	≤ Ø 54	≥ 1.5		11 - 28.5				EI 90 C/U
				13.5 - 28.5				EI 45 C/U
(Stainless) Steel / cast iron	≤ Ø 168.3	≥ 4.5	28.5	E 90 C/U				
			13 - 19	EI 45 C/U				
							E 120 C/U	

B.1.11 Multimastic FB1 - 2x 50 mm cavity 50 mm - Metal pipes insulated elastomer

B.1.11.1 Copper and steel pipes - Elastomer LS 400 / CS

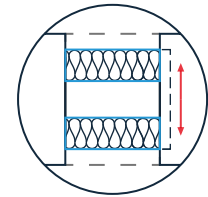
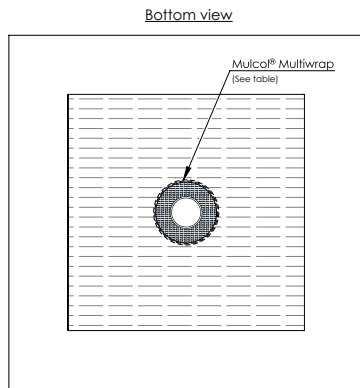

Position seal:
top, bottom or anywhere
in between

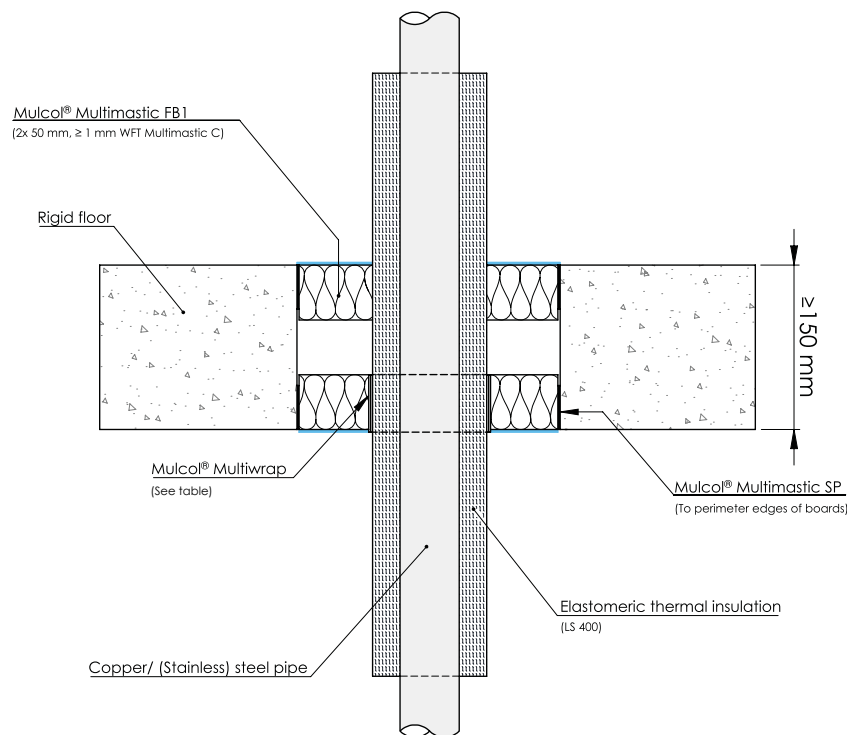

Drawing: PBrf.E-CU-MW2-MFB1.2.22.LS.C

Services	Pipe dimensions (mm)		Insulation			Product	Sealing (mm)	Classification
	Outer dimension	Wall thickness	Type	Thickness (mm)	Configuration			
Copper / (stainless) steel / cast iron	≤ Ø 12	≥ 1	ArmaFlex AF (min. class B-s3, d0 B _L -s3, d0)	11	LS 400 / CS	Multiwrap (2 layers)	Multimastic SP 0-20 x ≥ 5 (wxd) top of floor	EI 120 C/U
				E 240 C/U				
Copper / (stainless) steel / cast iron	≤ Ø 54	≥ 1.5		11 - 28.5				EI 90 C/U
				13.5 - 28.5				EI 45 C/U
(Stainless) Steel / cast iron	≤ Ø 168.3	≥ 4.5	28.5	E 90 C/U				
			13 - 19	EI 45 C/U				
							E 120 C/U	

B.1.11 Multimastic FB1 - 2x 50 mm cavity 50 mm - Metal pipes insulated elastomer

B.1.11.1 Copper and steel pipes - Elastomer LS 400 / CS

Services	Pipe dimensions (mm)		Insulation			Product	Sealing (mm)	Classification
	Outer dimension	Wall thickness	Type	Thickness (mm)	Configuration			
(Stainless) Steel / cast iron	≤ Ø 40	≥ 2.0	Kaiflex KK Plus (min. class B-s2, d0 B _L -s2, d0)	19	LS 400 / CS	Multiwrap (2 layers)	Multimastic SP 0-20 x ≥ 5 (wxd) top of floor	EI 45 C/U E 120 C/U

B.1.12 Multimastic FB2 - 1x 60 mm - Metal pipes insulated elastomer

B.1.12.1 Steel pipes - Elastomer LS 400 / CS

Bottom view

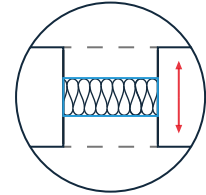
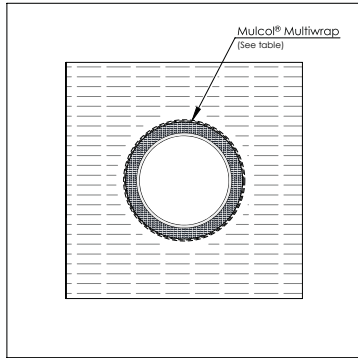

Position seal:
top, bottom or anywhere
in between

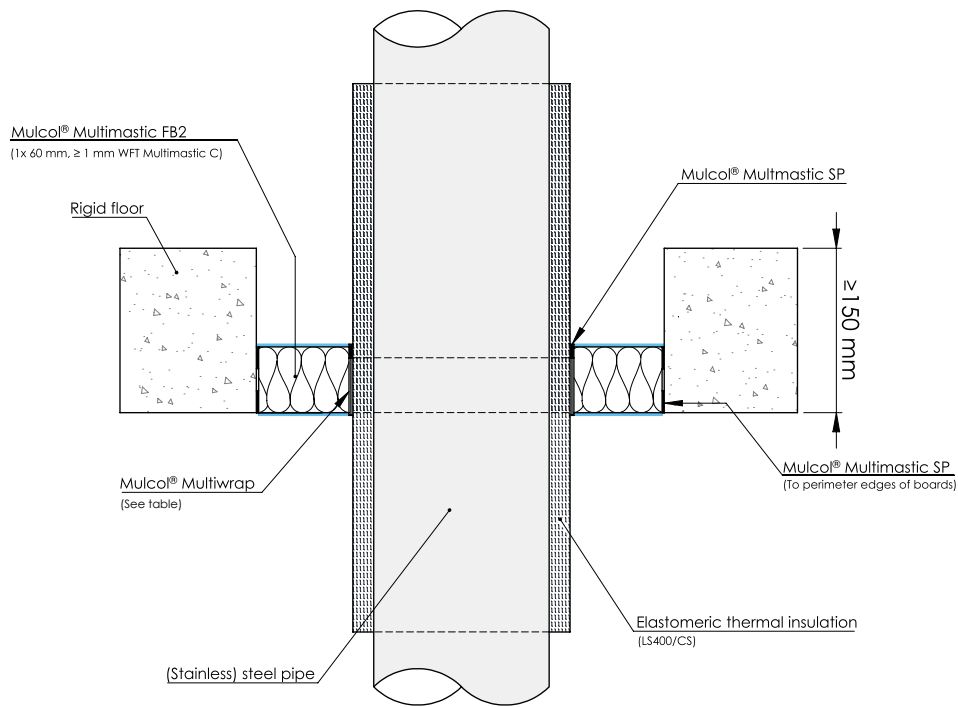

Drawing: PBrf.E-ST-MW2-MFB2.1.22.LS

Services	Pipe dimensions (mm)		Insulation			Product	Sealing (mm)	Classification
	Outer dimension	Wall thickness	Type	Thickness (mm)	Configuration			
(Stainless) Steel / cast iron	≤ Ø 168.3	≥ 4.5	ArmaFlex AF (min. class B-s3, d0 B _L -s3, d0)	13 - 19	LS 400 / CS	Multiwrap (2 layers)	Multimastic SP 0-20 x ≥ 5 (wxd) top of floor	EI 45 C/U E 120 C/U

B.1.13 Multimortar - ≥ 100 mm - Metal pipes insulated elastomer

B.1.13.1 Copper and steel pipes - Elastomer LS 400 / CS

Bottom view

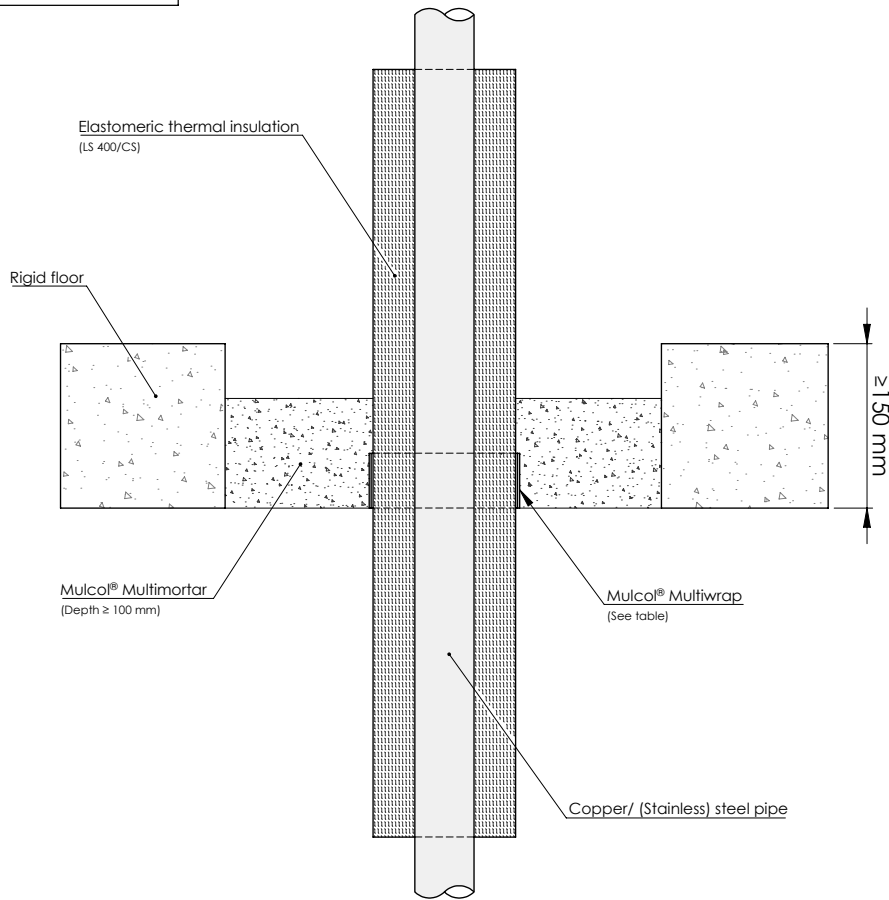
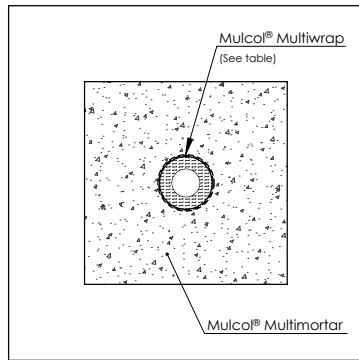

Drawing: RF.E-CU-MW-MM1.2.22

Services	Dimensions (mm)		Type	Insulation		Product	Classification
	Outer dimension	Wall thickness		Thickness (mm)	Configuration		
Copper / (stainless) steel / cast iron	$\leq \varnothing 12$	≥ 1.0	ArmaFlex AF (min. class B-s3, d0 B _L -s3, d0)	11	LS 400 / CS	Multiwrap (1 layer)	EI 180 C/U E 240 C/U
				11 - 19			EI 90 C/U E 240 C/U
13 - 19	EI 180 C/U E 240 C/U						
(Stainless) Steel / cast iron	$\leq \varnothing 40$	≥ 2.0		19	CS		EI 120 C/U E 240 C/U
	$\leq \varnothing 168.3$			≥ 4.5	19		LS 400 / CS

B.1.13 Multimortar - ≥ 100 mm - Metal pipes insulated elastomer

B.1.13.1 Copper and steel pipes - Elastomer LS 400 / CS

Services	Dimensions (mm)		Insulation			Product	Classification	
	Outer dimension	Wall thickness	Type	Thickness (mm)	Configuration			
Copper / (stainless) steel / cast iron	$\leq \varnothing 12$	≥ 1.0	ArmaFlex AF (min. class B-s3, d0 B _L -s3, d0)	11	LS 400 / CS	Multiwrap (2 layers)	EI 120 C/U E 240 C/U	
				11 - 38			EI 90 C/U	
(Stainless) Steel / cast iron	$\leq \varnothing 40$	25		EI 180 C/U				
		25 - 38		EI 90 C/U				
Copper / (stainless) steel / cast iron	$\leq \varnothing 54$	≥ 1.5		13.5 - 28.5			EI 45 C/U E 90 C/U	
				28.5 - 38			EI 120 C/U E 180 C/U	
(Stainless) Steel / cast iron	$\leq \varnothing 324$	≥ 6.3		25			EI 30 C/U E 120 C/U	
							EI 60 C/U E 120 C/U	
	$\leq \varnothing 40$	≥ 1.0		50			CS	EI 240 C/U
								EI 45 C/U E 240 C/U
$\leq \varnothing 324$	≥ 6.3			EI 120 C/U E 240 C/U				

B.1.14 Multimortar - ≥ 150 mm - Metal pipes insulated elastomer

B.1.14.1 Copper and steel pipes - Elastomer LS 400 / CS

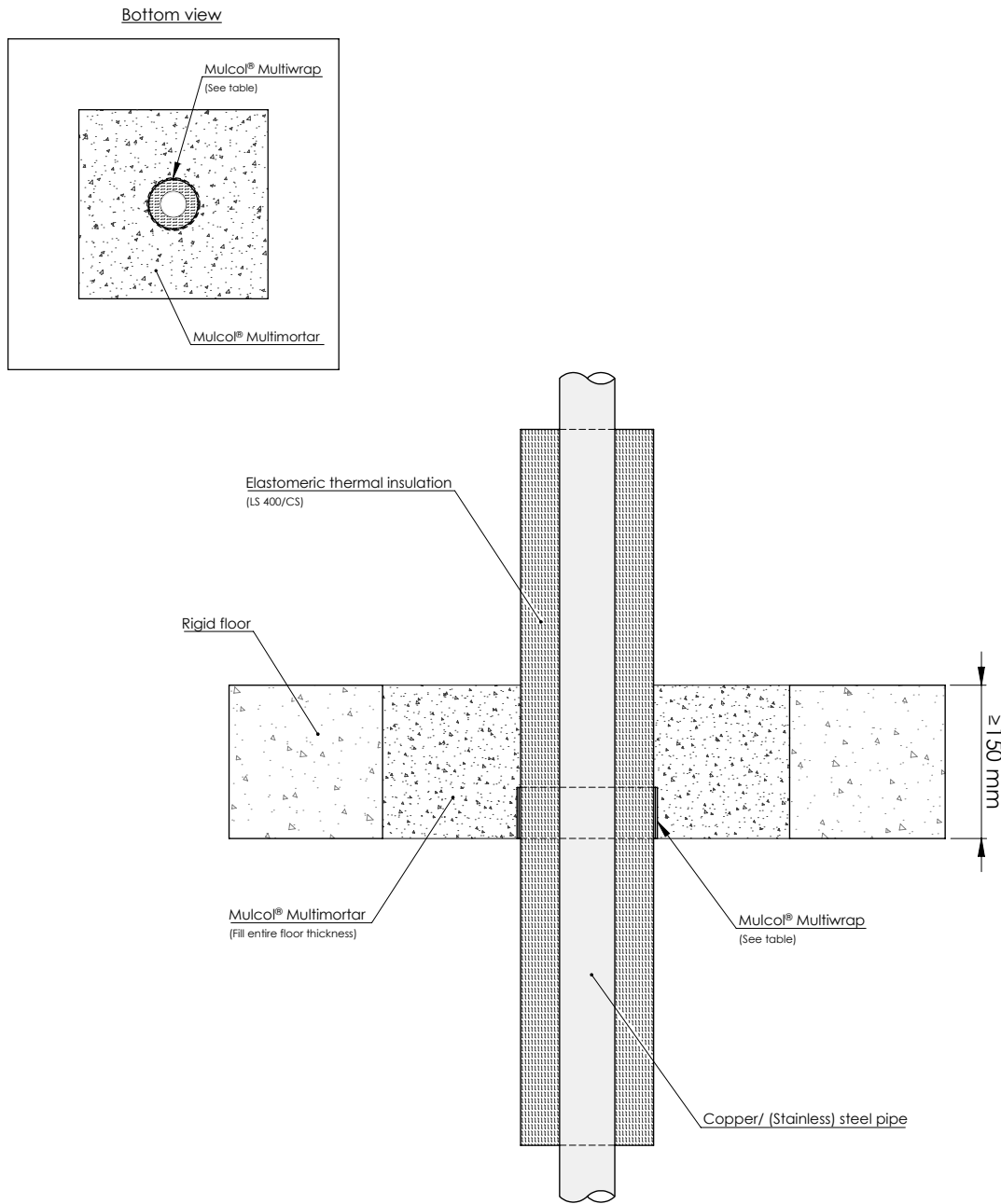

Drawing: RF.E-CU-MW-MM1.3.22

Services	Dimensions (mm)		Type	Insulation		Product	Classification
	Outer dimension	Wall thickness		Thickness (mm)	Configuration		
Copper / (stainless) steel / cast iron	$\leq \varnothing 12$	≥ 1.0	ArmaFlex AF (min. class B-s3, d0 B _L -s3, d0)	11	LS 400 / CS	Multiwrap (1 layer)	EI 180 C/U
				E 240 C/U			
	11 - 19			EI 90 C/U			
$\leq \varnothing 40$	≥ 2.0	13 - 19		CS	E 240 C/U		
		EI 180 C/U					
		$\leq \varnothing 168.3$		≥ 4.5	19		LS 400 / CS
			E 240 C/U				
				EI 120 C/U			
				E 240 C/U			
					EI 90 C/U		
					E 240 C/U		

B.1.14 Multimortar - ≥ 150 mm - Metal pipes insulated elastomer

B.1.14.1 Copper and steel pipes - Elastomer LS 400 / CS

Services	Dimensions (mm)		Insulation			Product	Classification		
	Outer dimension	Wall thickness	Type	Thickness (mm)	Configuration				
Copper / (stainless) steel / cast iron	≤ Ø 12	≥ 1.0	ArmaFlex AF (min. class B-s3, d0 B _L -s3, d0)	11	LS 400 / CS	Multiwrap (2 layers)	EI 120 C/U E 240 C/U		
				11 - 38			EI 90 C/U		
(Stainless) Steel / cast iron	≤ Ø 40	25		EI 180 C/U					
		25 - 38		EI 90 C/U					
Copper / (stainless) steel / cast iron	≤ Ø 54	≥ 1.5		13.5 - 28.5			EI 45 C/U E 90 C/U		
				28.5 - 38			EI 120 C/U E 180 C/U		
(Stainless) Steel / cast iron	≤ Ø 54	≥ 1.5		25			EI 30 C/U E 120 C/U		
	≤ Ø 324	≥ 6.3					EI 60 C/U E 120 C/U		
	≤ Ø 40	≥ 1.0					50	Multiwrap (3 layers)	EI 240 C/U
	≤ Ø 324	≥ 6.3							EI 45 C/U E 240 C/U
			CS	EI 120 C/U E 240 C/U					

B.1.15 Multimortar + Multimastic FB - ≥ 100 mm - Metal pipes insulated elastomer

B.1.15.1 Copper and steel pipes - Elastomer LS 400 / CS

Bottom view

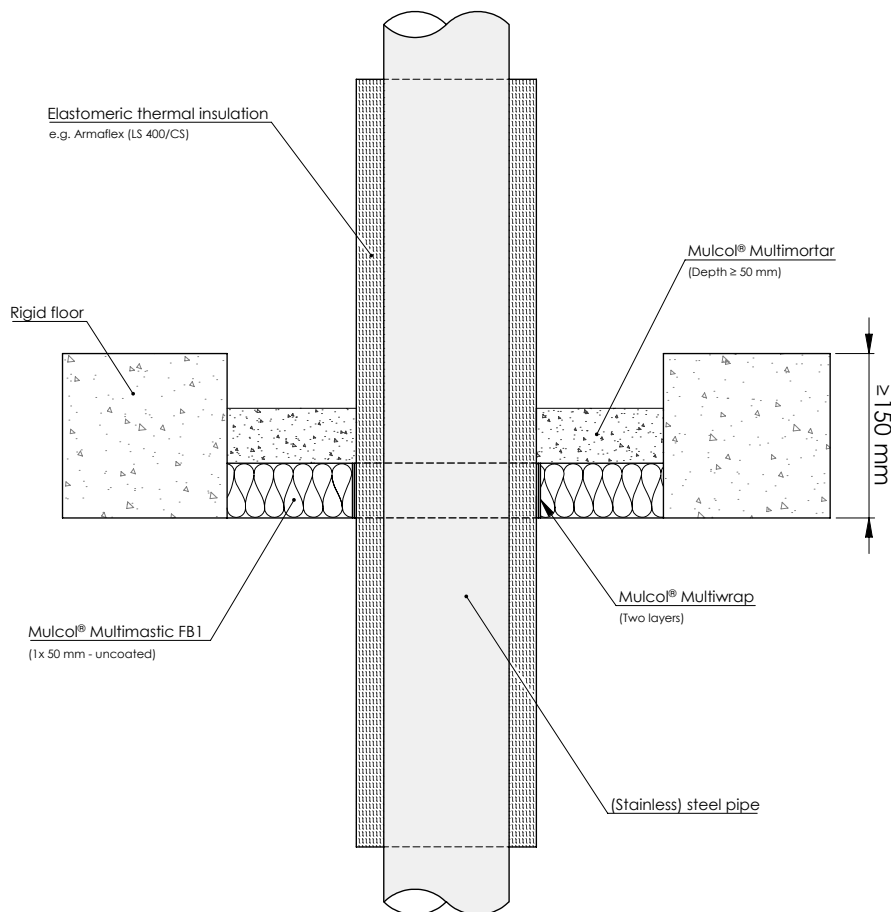
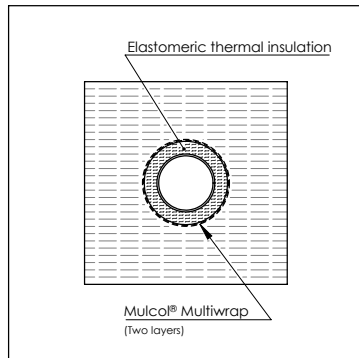

Drawing: RF-ST-MW2-MM2.5.22

Services	Dimensions (mm)		Insulation			Product	Classification
	Outer dimension	Wall thickness	Type	Thickness (mm)	Configuration		
Copper / (stainless) steel / cast iron	≤ Ø 12	≥ 1.0	ArmaFlex (min. class B-s3, d0 B _L -s3, d0)	11	LS 400 / CS	Multiwrap (2 layers)	EI 120 C/U
				E 180 C/U			
	EI 90 C/U						
≤ Ø 54	≥ 1.5	13.5 - 38		EI 45 C/U			
		28.5 - 38	E 90 C/U				
(Stainless) Steel / cast iron	≤ Ø 168.3	≥ 4.5		13 - 19			EI 45 C/U
							E 120 C/U

B.1.16 Multimortar + Multimastic FB - ≥ 150 mm - Metal pipes insulated elastomer

B.1.16.1 Copper and steel pipes - Elastomer LS 400 / CS

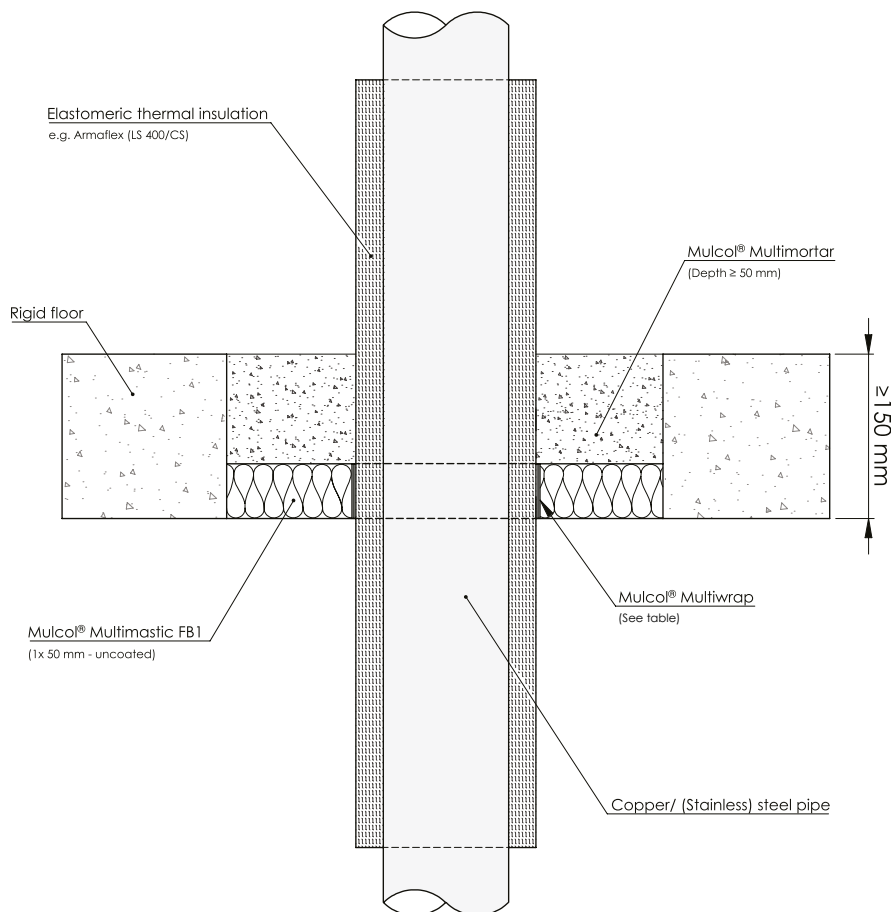
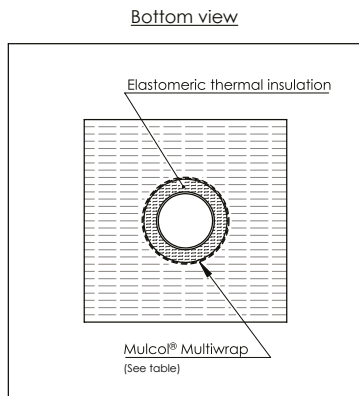

Drawing: RF.E-CU-MW-MM2.7.22

Services	Dimensions (mm)		Insulation			Product	Classification
	Outer dimension	Wall thickness	Type	Thickness (mm)	Configuration		
Copper / (stainless) steel / cast iron	≤ Ø 12	≥ 1.0	ArmaFlex (min. class B-s3, d0 B _L -s3, d0)	11	LS 400 / CS	Multiwrap (2 layers)	EI 120 C/U E 240 C/U
				11 - 38			EI 90 C/U
	≤ Ø 54	≥ 1.5		13.5 - 38			EI 45 C/U E 90 C/U
28.5 - 38				EI 90 C/U			
(Stainless) Steel / cast iron	≤ Ø 168.3	≥ 4.5		13 - 19		EI 45 C/U E 120 C/U	

C.1 Flexible and rigid wall - General

C.1.1 Mutual distances & distance to first support

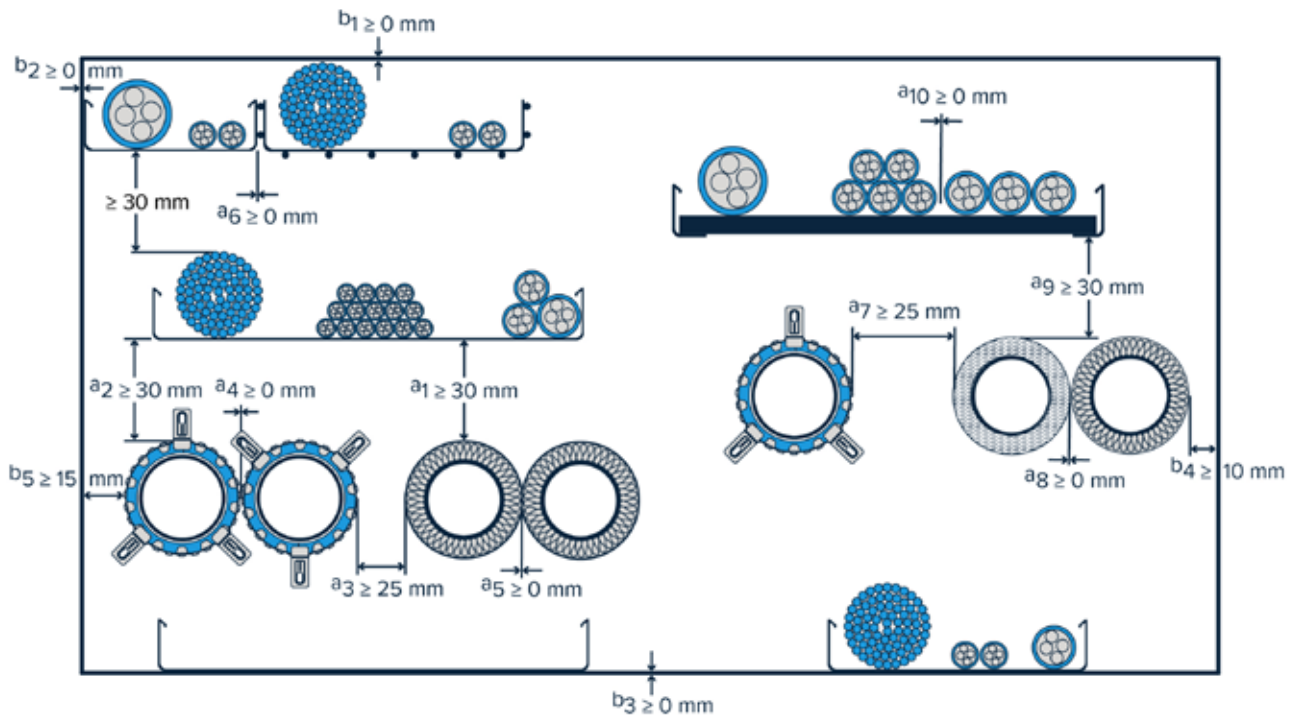

Mutual distances Mixed Penetration Seal

- a_1 Distance between cables/cable trays and metal pipes
- a_2 Distance between cables/cable trays and plastic pipes
- a_3 Distance between metal pipes and plastic pipes
- a_4 Distance between plastic pipes
- a_5 Distance between metal pipes with non-combustible insulation
- a_6 Distance between cable trays
- a_7 Distance between plastic pipes and pipes with combustible insulation
- a_8 Distance between pipes with non-combustible insulation and pipes with combustible insulation
- a_9 Distance between cables/cable trays and pipes with combustible insulation
- a_{10} Distance between cables stacked together or in a row
- b_1 Distance between cables/cable trays and the upper seal edge
- b_2 Distance between cables/cable trays and the side seal edge
- b_3 Distance between cables/cable tray and the lower seal edge
- b_4 Distance between metal pipes and all seal edges
- b_5 Distance between plastic pipes and all seal edges

Service support construction

First support for all services at 450 mm, except cable trays at 250 mm.

C.1.2 Flexible and rigid wall - Maximum seal dimensions

C.1.2.1 2x 50 mm no aperture framing

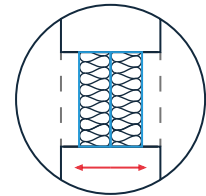

Position seal:
right, left or anywhere
in between

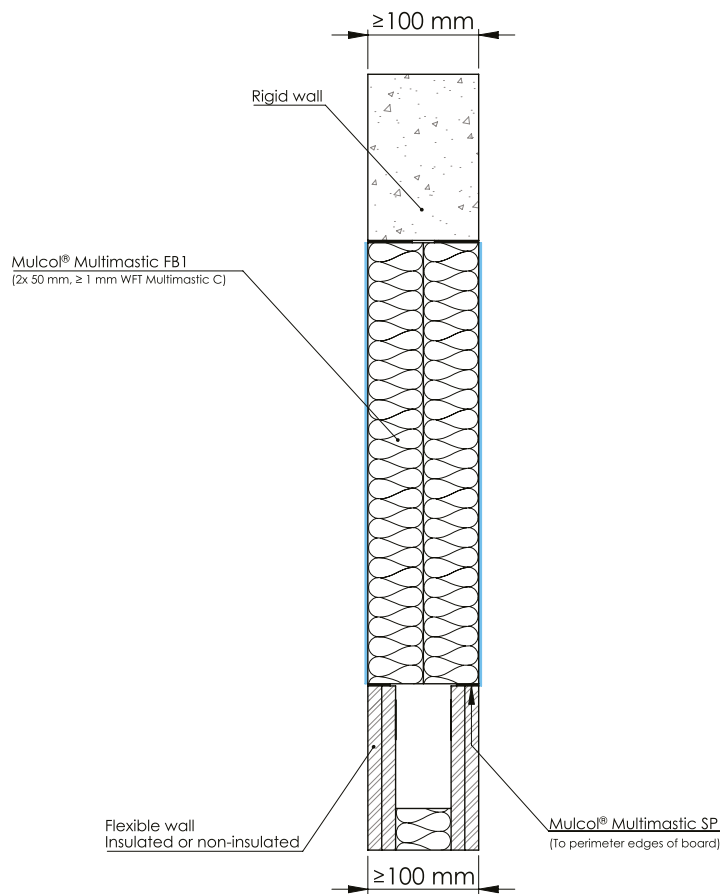

Drawing: PBfw.E-BS-MFB1.2.10

Services	Classification
Maximum seal size 1500 x 2500 mm (width x heigth or height x width) With a maximum surface of 3 m ²	EI 60
Maximum circular seal size Ø 1954 mm	
Maximum seal size 1200 x 1200 mm With a maximum surface of 1.44 m ²	EI 60, E 90
Maximum circular seal size Ø 1354 mm	
Maximum seal size 625 x 475 mm (w x h) With a maximum surface of 0.24 m ²	EI 120
Maximum circular seal size Ø 550 mm	

C.1.2 Flexible and rigid wall - General - Maximum seal dimensions

C.1.2.2 2x 50 mm with aperture framing

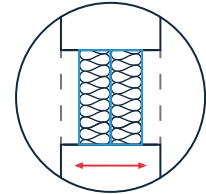

Position seal:
right, left or anywhere
in between

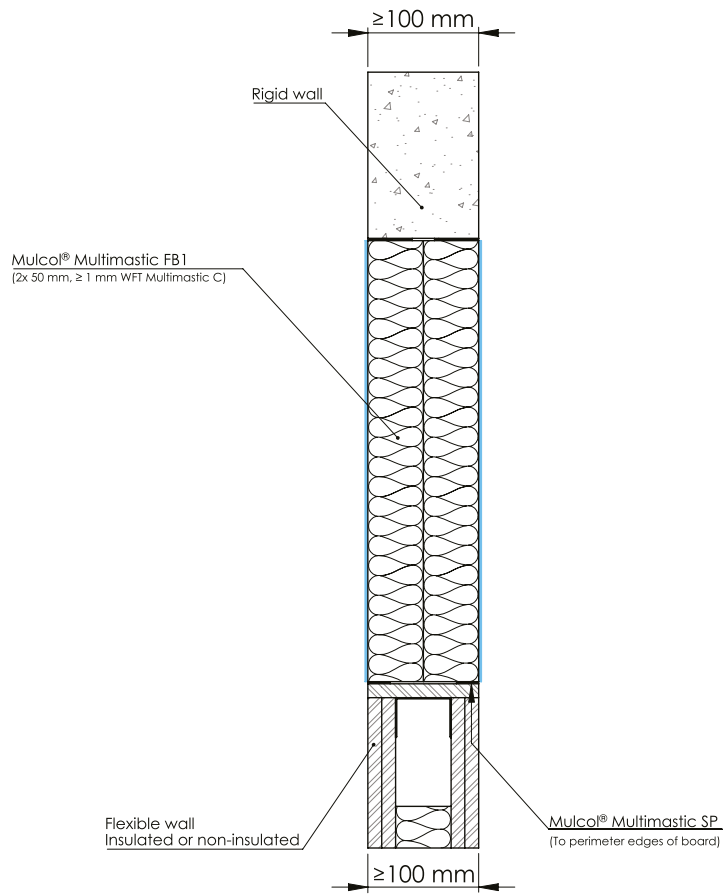

Drawing: PBfw.E-BS-A-MFB1.2.10

Services	Classification
Maximum seal size 1500 x 2500 mm (width x height or height x width) With a maximum surface of 3 m ²	EI 120
Maximum circular seal size Ø 1954 mm	
Maximum seal size 1200 x 2000 mm (width x height or height x width) With a maximum surface of 2.44 m ²	EI 180
Maximum circular seal size Ø 1748 mm	

C.1.2 Flexible and rigid wall - General - Maximum seal dimensions

C.1.2.3 Multimastic FB1 - 2x 50 mm - Pattress

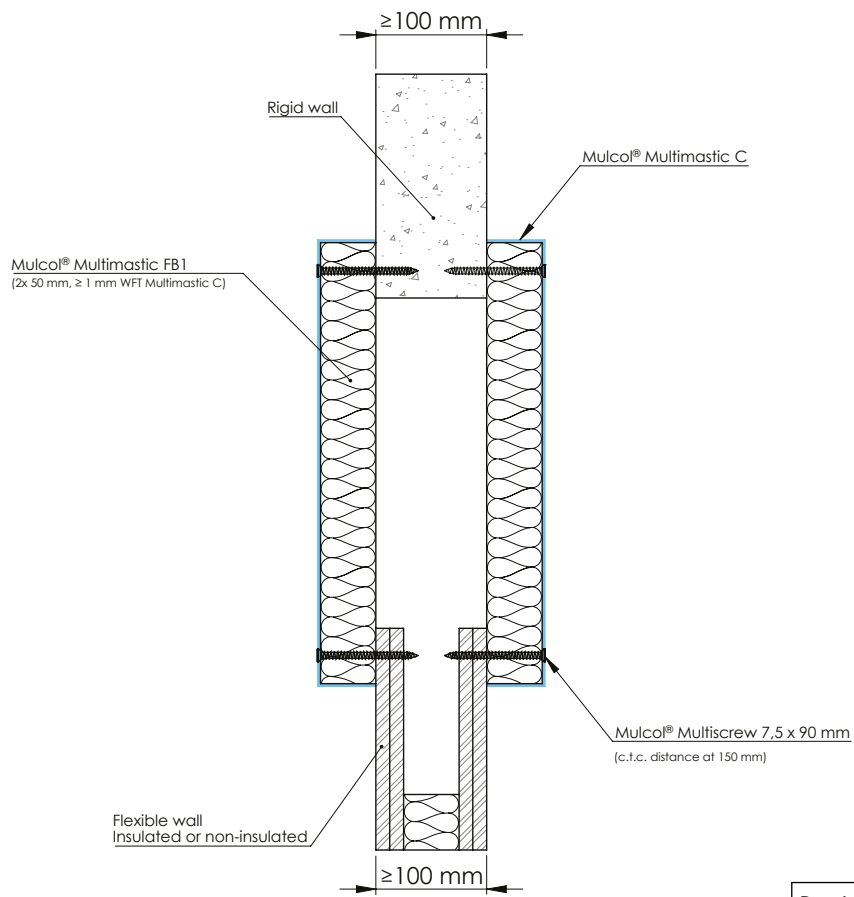

Drawing: PBPfw-BS-MFB1.2.10

Services	Classification
Maximum seal size 750 x 1250 mm (width x height or height x width) With a maximum surface of 0.75 m ²	EI 120
Maximum circular seal size \varnothing 1093 mm	

C.1.2 Flexible and rigid wall - General - Maximum seal dimensions

C.1.2.4 Multimastic FB2 - 1x 60 mm with aperture framing

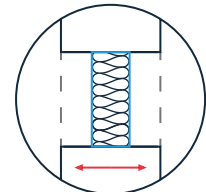

Position seal:
right, left or anywhere
in between

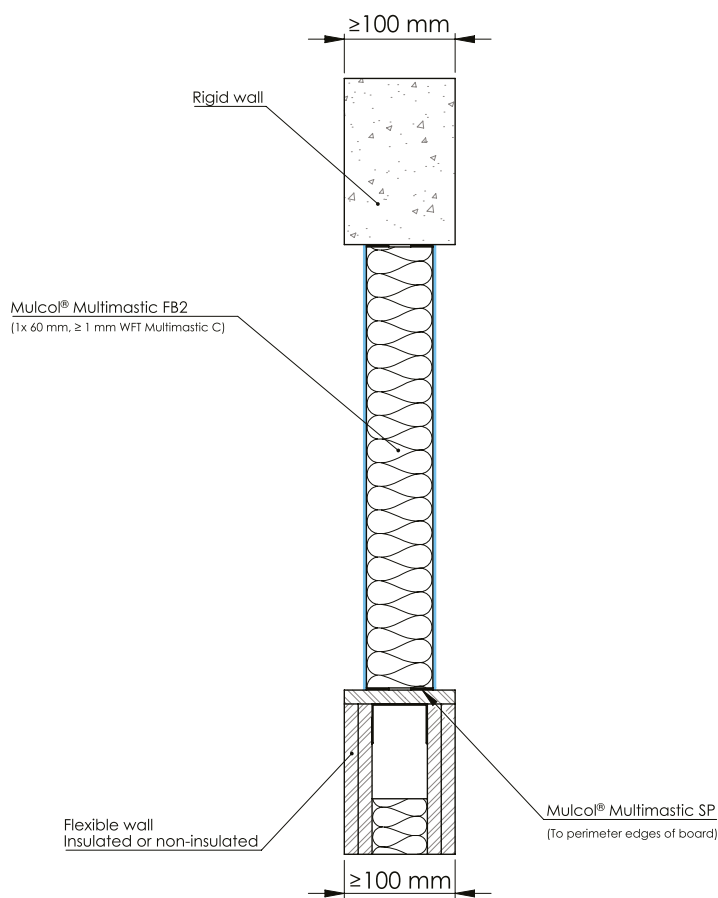

Drawing: PBfw.E-BS-MFB2.1.10

Services	Classification
Maximum seal size 1500 x 2500 mm (width x height or height x width) With a maximum surface of 3 m ²	EI 60
Maximum circular seal size Ø 1748 mm	
Maximum seal size 1500 x 1500 mm With a maximum surface of 1.72 m ²	
Maximum seal size 1200 x 1200 mm With a maximum surface of 1.44 m ²	EI 60, E 90
Maximum circular seal size Ø 1354 mm	
Maximum seal size 563 x 525 mm (width x height or height x width) With a maximum surface of 0.24 m ²	EI 90
Maximum circular seal size Ø 548 mm	
Maximum seal size 450 x 420 mm (width x height or height x width) With a maximum surface of 0.19 m ²	EI 120
Maximum circular seal size Ø 491 mm	

C.1.2 Flexible and rigid wall - General - Maximum seal dimensions

C.1.2.5 Multimastic FB2 - 1x 60 mm with aperture framing

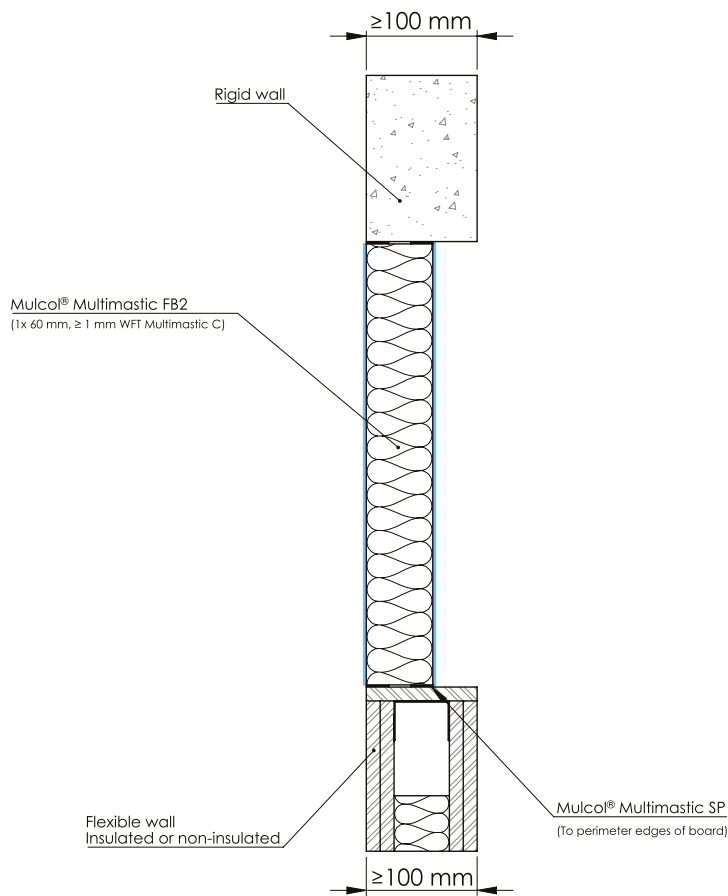

Drawing: PBfw.E-BS-fs-MFB2.1.10

Services	Classification
Maximum seal size 1500 x 2500 mm (width x height or height x width) With a maximum surface of 3 m ²	EI 60
Maximum circular seal size Ø 1748 mm	
Maximum seal size 425 x 265 mm (width x height or height x width) With a maximum surface of 0.11 m ²	EI 90, E 120
Maximum circular seal size Ø 379 mm	
Maximum seal size 531 x 331 mm (width x height or height x width) With a maximum surface of 0.14 m ²	EI 60, E 120
Maximum circular seal size Ø 423 mm	

C.1.3 Rigid wall - General - Maximum seal dimensions

C.1.3.1 Multimastic FB2 - 2x 60 mm with cavity ≤ 30 mm

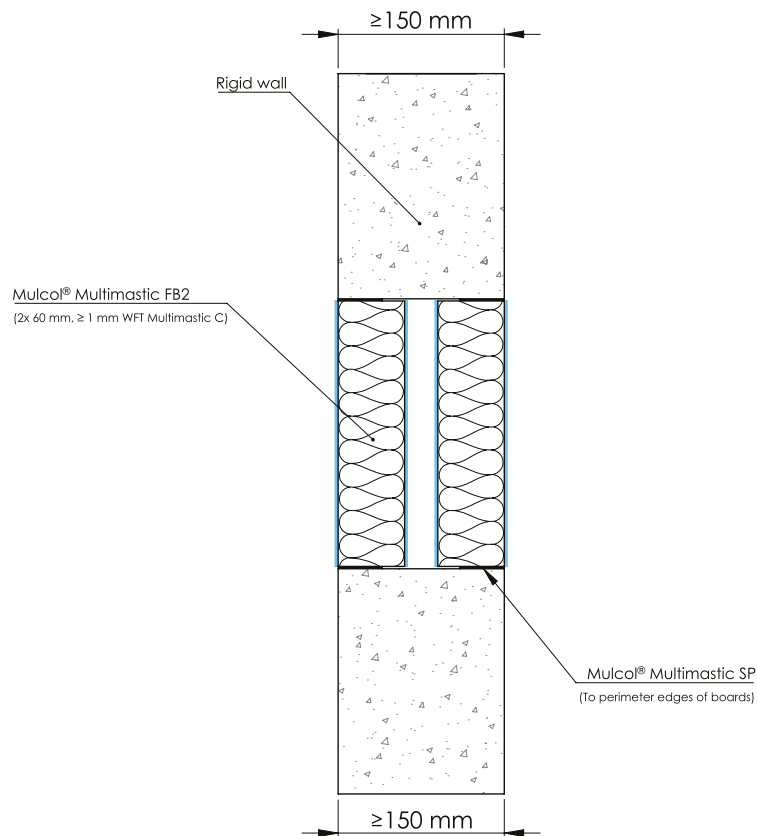
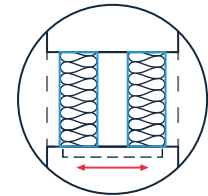

Drawing: RW150.E-BS-MFB2.2.10

Services	Classification
Maximum seal size 1200 x 1200 mm With a maximum surface of 1.44 m ²	EI 240
Maximum circular seal size \varnothing 1354 mm	

C.1.3 Rigid wall - General - Maximum seal dimensions

C.1.3.2 Multimastic FB2 - 2x 60 mm - Pattress fixed to wall

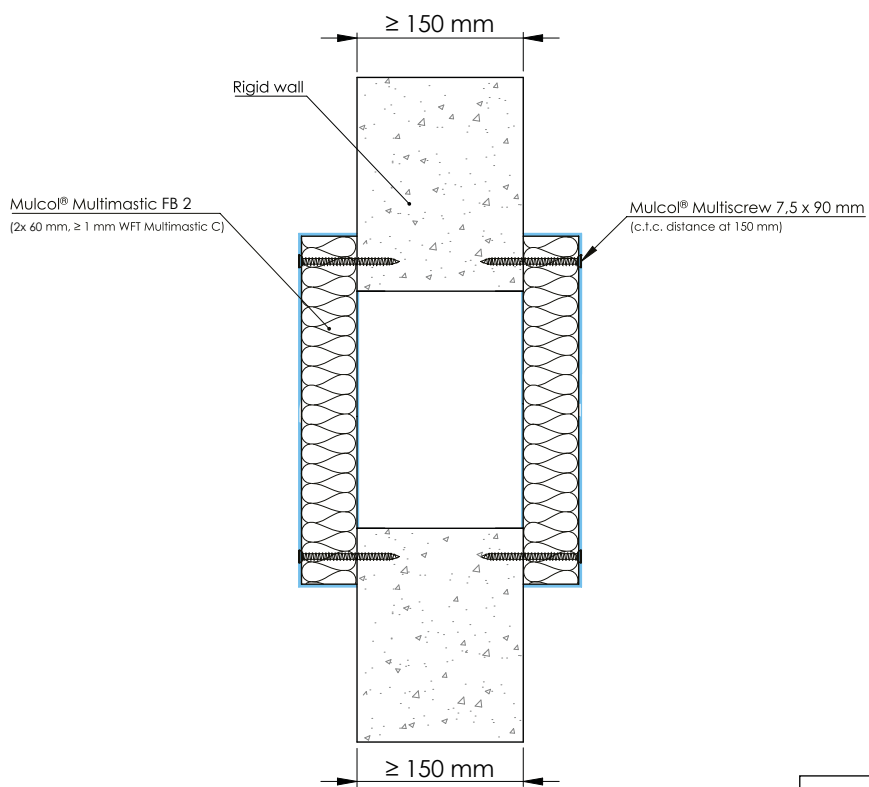

Drawing: PBPrw150.E-BS-MFB2.2.10

Services	Classification
Maximum seal size 750 x 600 mm (width x height or height x width) With a maximum surface of 0.45 m ²	EI 240
Maximum circular seal size Ø 757 mm	

C.1.4 Flexible and rigid wall - Maximum seal dimensions

C.1.4.1 Multimortar - ≥ 100 mm

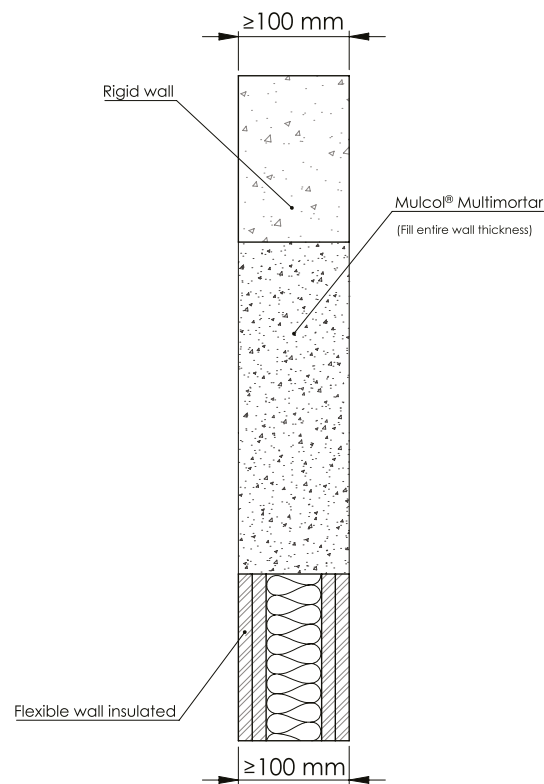

Drawing: FW.E-BS-MM1.2.10

Services	Classification
Maximum seal size 1500 x 2500 mm (width x height or height x width) With a maximum surface of 3 m ²	EI 120
Maximum circular seal size \varnothing 1954 mm	
Maximum seal size 1200 x 2000 mm (width x height or height x width) With a maximum surface of 2.4 m ²	EI 180
Maximum circular seal size \varnothing 1748 mm	

C.1.4 Flexible and rigid wall - General - Maximum seal dimensions

C.1.4.2 Multimortar + Mulcol Multimastic FB system - ≥ 100 mm

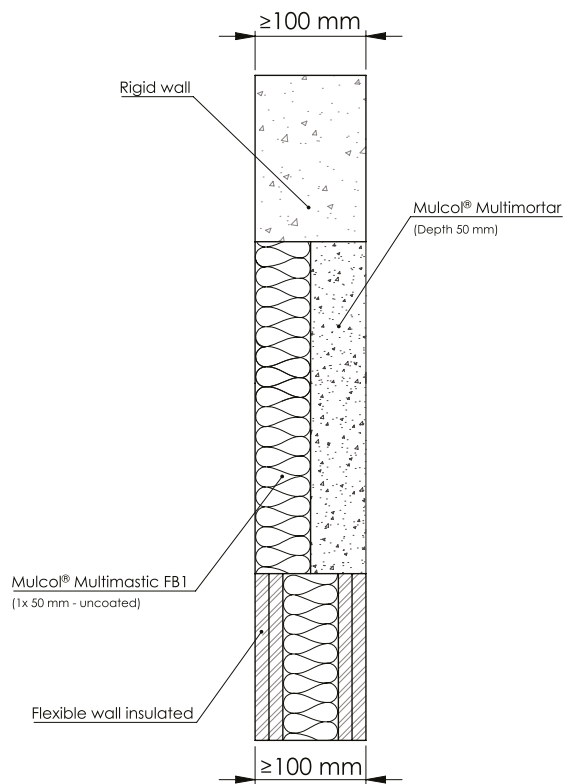

Drawing: FW.E-BS-MM2.5.10

Services	Classification
Maximum seal size 1500 x 2500 mm (width x height or height x width) With a maximum surface of 3 m ²	EI 60
Maximum circular seal size Ø 1954 mm	
Maximum seal size 1200 x 1200 mm (width x height or height x width) With a maximum surface of 1.44 m ²	EI 60, E 90
Maximum circular seal size Ø 1354 mm	
Maximum seal size 625 x 750 mm (width x height or height x width) With a maximum surface of 0.38 m ²	EI 120
Maximum circular seal size Ø 691 mm	

C.1.4 Flexible and rigid wall - General - Maximum seal dimensions

C.1.4.3 Multimortar 25 mm + Multimastic FB 50 mm + Multimortar 25 mm - ≥ 100 mm

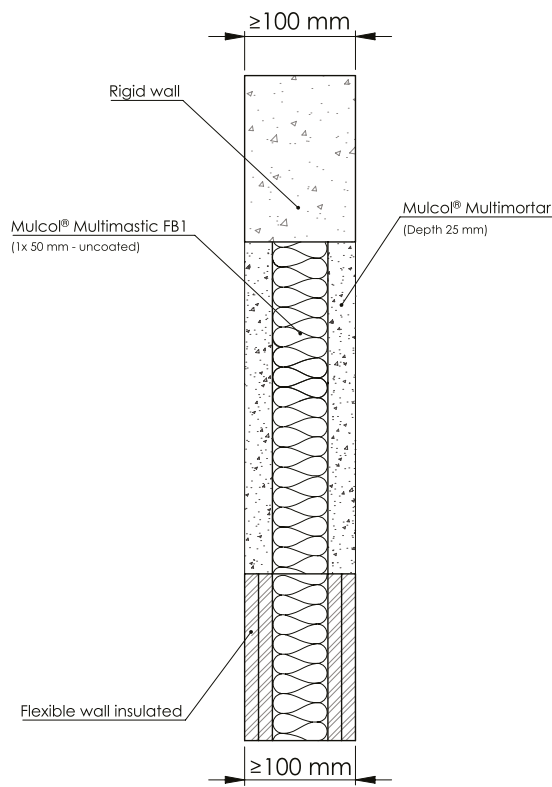

Drawing: FW.E-BS-MM3.4.10

Services	Classification
Maximum seal size 1500 x 2500 mm (width x height or height x width) With a maximum surface of 3 m ²	EI 60
Maximum circular seal size Ø 1954 mm	
Maximum seal size 1200 x 1200 mm (width x height or height x width) With a maximum surface of 1.44 m ²	EI 60, E 90
Maximum circular seal size Ø 1354 mm	
Maximum seal size 625 x 750 mm (width x height or height x width) With a maximum surface of 0.38 m ²	EI 120
Maximum circular seal size Ø 691 mm	

C.2 Rigid floor - General

C.2.1 Mutual distances & distance to first support

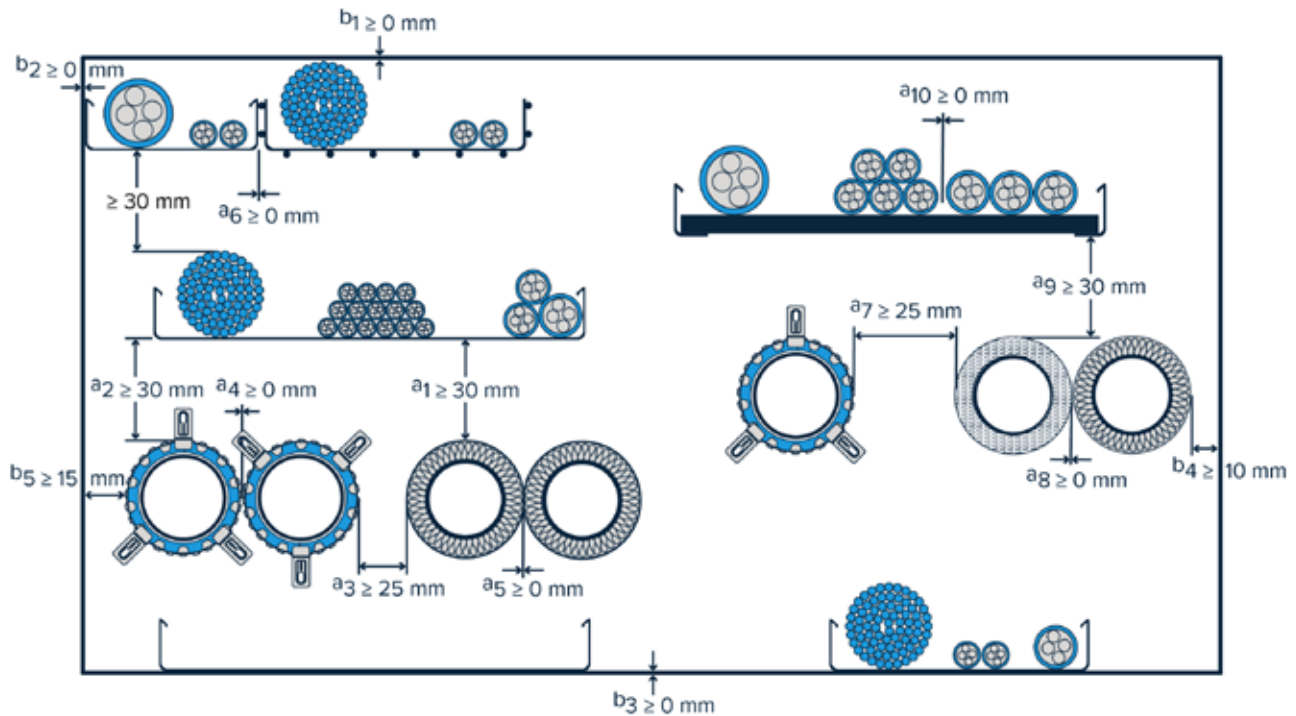

Mutual distances Mixed Penetration Seal

- a_1 Distance between cables/cable trays and metal pipes
- a_2 Distance between cables/cable trays and plastic pipes
- a_3 Distance between metal pipes and plastic pipes
- a_4 Distance between plastic pipes
- a_5 Distance between metal pipes with non-combustible insulation
- a_6 Distance between cable trays
- a_7 Distance between plastic pipes and pipes with combustible insulation
- a_8 Distance between pipes with non-combustible insulation and pipes with combustible insulation
- a_9 Distance between cables/cable trays and pipes with combustible insulation
- a_{10} Distance between cables stacked together or in a row
- b_1 Distance between cables/cable trays and the upper seal edge
- b_2 Distance between cables/cable trays and the side seal edge
- b_3 Distance between cables/cable tray and the lower seal edge
- b_4 Distance between metal pipes and all seal edges
- b_5 Distance between plastic pipes and all seal edges

Service support construction

First support for all services at 450 mm, except cable trays at 250 mm.

C.2.2 Rigid floor - General - Maximum seal dimensions

C.2.2.1 Multimastic FB1 - 2x 50 mm no cavity

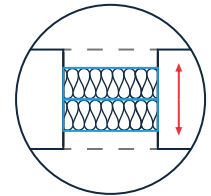

Position seal:
top, bottom or anywhere
in between

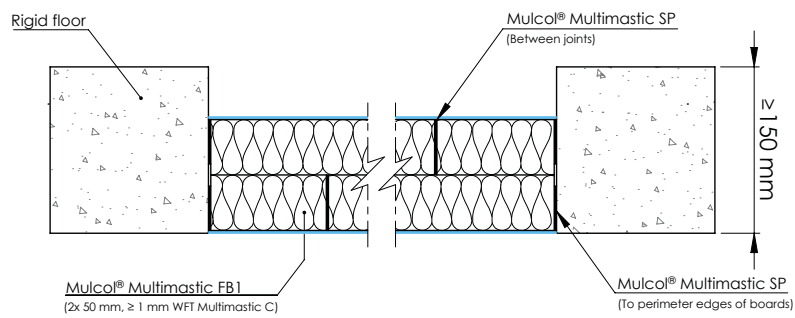

Drawing: PBrf.E-BS-MFB1.2.10

Services	Classification
Maximum seal size 1200 x 1200 mm	EI 90, E 120
Maximum seal size 9000 x 900 mm	
Maximum circular seal size Ø 1354 mm	
Maximum seal size 600 x 400 mm	EI 120
Maximum circular seal size Ø 553 mm	
Maximum seal size 450 x 450 mm	EI 240
Maximum circular seal size Ø 508 mm	

C.2.2 Rigid floor - General - Maximum seal dimensions

C.2.2.2 Multimastic FB1 - 2x 50 mm cavity ≤ 50 mm

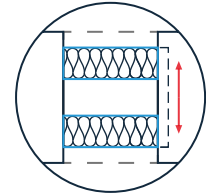

Position seal:
top, bottom or anywhere
in between

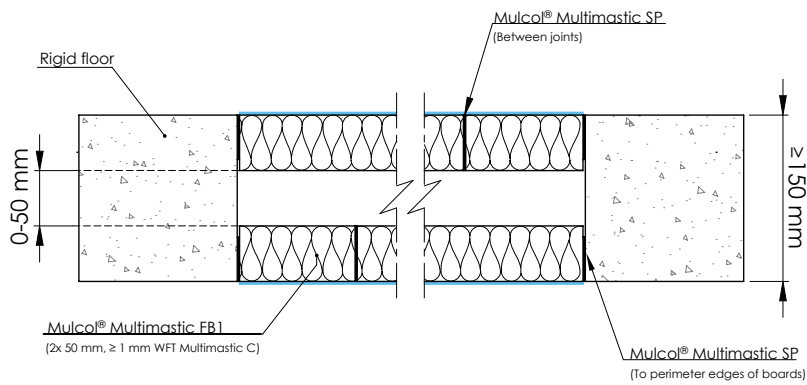

Drawing: PBrf.E-BS-MFB1.2.10.C

Services	Classification
Maximum seal size 1200 x 1200 mm	EI 90, E 120
Maximum seal size 9000 x 900 mm	
Maximum circular seal size Ø 1354 mm	
Maximum seal size 950 x 485 mm	EI 120
Maximum circular seal size Ø 766 mm	
Maximum seal size 450 x 450 mm	EI 240
Maximum circular seal size Ø 508 mm	

C.2.2 Rigid floor - General - Maximum seal dimensions

C.2.2.3 Multimastic FB2 - 1x 60 mm

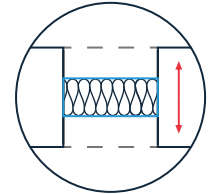

Position seal:
top, bottom or anywhere
in between

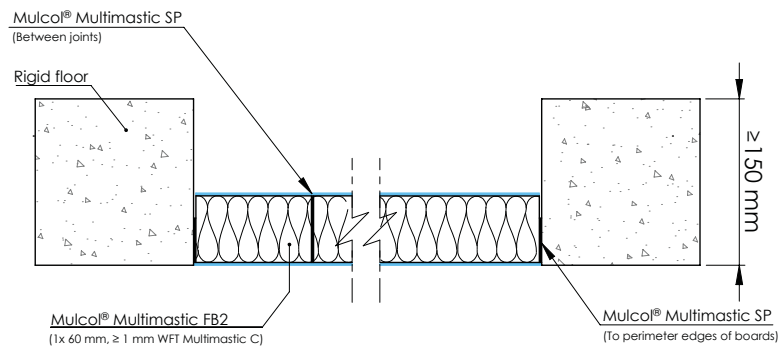

Drawing: PBrf.E-BS-MFB2.1.10

Services	Classification
Maximum seal size 1200 x 1200 mm Maximum seal size 9000 x 900 mm	EI 90, E 120
Maximum circular seal size Ø 1354 mm	

C.2.3 Rigid floor - General - Maximum seal dimensions

C.2.3.1 Multimortar - ≥ 100 mm

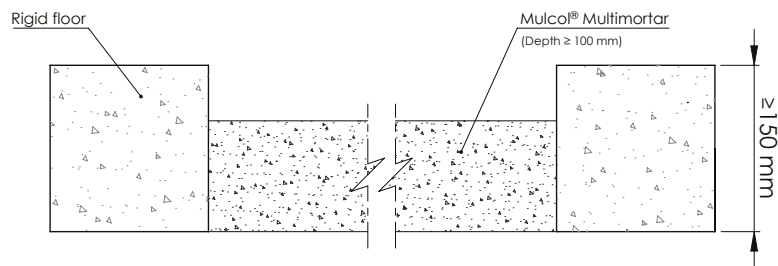

Drawing: RF.E-BS-MM1.3.10

Services	Classification
Maximum seal size 1200 x 1000 mm	EI 180
Maximum seal size 8800 x 880 mm	
Maximum circular seal size \varnothing 1236 mm	
Maximum seal size 1000 x 750 mm	EI 240
Maximum circular seal size \varnothing 977 mm	

C.2.3 Rigid floor - General - Maximum seal dimensions

C.2.3.2 Multimortar + Mulcol Multimastic FB system - ≥ 100 mm

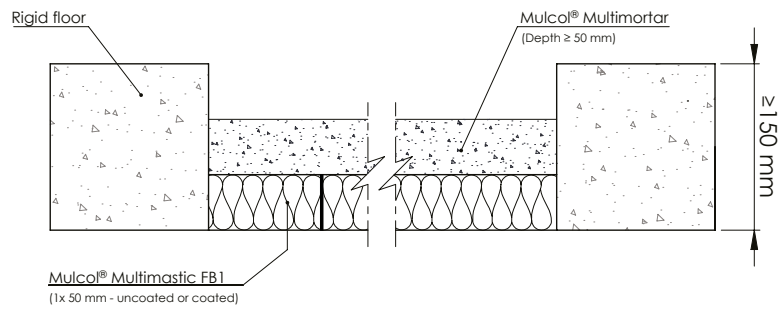

Drawing: RF.E-BS-MM2.5.10

Services	Classification
Maximum seal size 1200 x 1000 mm	EI 180
Maximum seal size 8800 x 880 mm	
Maximum circular seal size \varnothing 1236 mm	

C.2.3 Rigid floor - General - Maximum seal dimensions

C.2.3.3 Multimortar + Mulcol Multimastic FB system - ≥ 150 mm

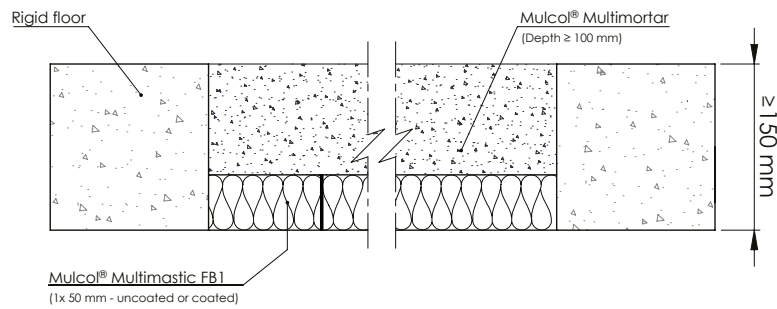

Drawing: RF.E-BS-MM2.2.10

Services	Classification
Maximum seal size 1200 x 1000 mm	EI 180
Maximum seal size 8800 x 8800 mm	
Maximum circular seal size \varnothing 1236 mm	
Maximum seal size 450 x 450 mm	EI 240
Maximum circular seal size \varnothing 508 mm	

C.3 Wall configurations

C.3.1 Allowed wall configurations

The use of Mulcol® Multimastic C is allowed in all double sided flexible wall constructions (with or without insulation) of the same or higher fire resistance classification in accordance with EN 13501-2, with a lining made of gypsum boards (EN 520) or Calcium Silicate boards which are CE marked for the application as lining of flexible wall, if their construction is in accordance with the rules given below.

Field of direct application rules for double-sided flexible wall constructions:

- flexible wall constructions as shown in solutions given in Annex A of this document;
- flexible wall constructions with the same or higher number of board layers of the same or higher board thickness on each side of the wall, with insulation of any type or without insulation;
- flexible wall constructions with a reduced number of board layers but the same or higher board thickness on each side of the wall as tested, with insulation of any type or without insulation;
- flexible wall constructions with timber studs, no part of the penetration seal closer than 100 mm to any stud or nogging piece, the cavity closed between the penetration seal and the stud/nogging piece with minimum 100 mm of insulation of class A1 or A2 in accordance with EN 13501-1;
- rigid constructions of an overall thickness equal to or greater than that given in the solutions in Annex A and a minimum density of 350 kg/m³. In case of hollow brick wall the same rules regarding aperture framing apply as for double-sided flexible walls.

Allowed constructions (not limited by):

Flexible walls, not insulated, partially removed insulation or fully insulated with any type of insulation.

e.g.:

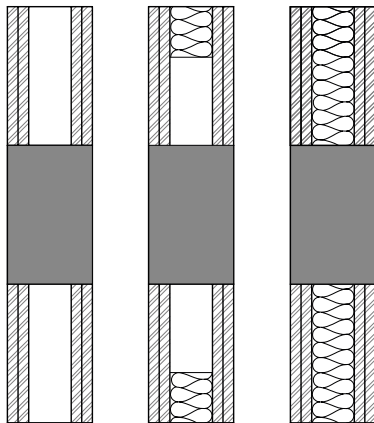

Double stud walls, separated by ≥ 0 mm, not insulated, partially insulated or fully insulated with any type of insulation.

e.g.:

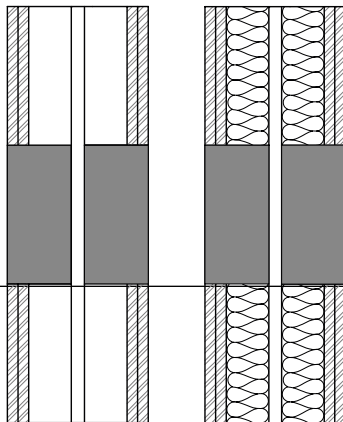

C.3 Wall configurations

C.3.1 Allowed wall configurations

Walls with a reduced number of board layers but the same or higher overall lining thickness on each side of the wall as shown in the solutions in Annex A.

Walls with a higher number of board layers, where individual boards are thinner yet the overall lining thickness is at least that of shown in the solutions in Annex A.

e.g.:

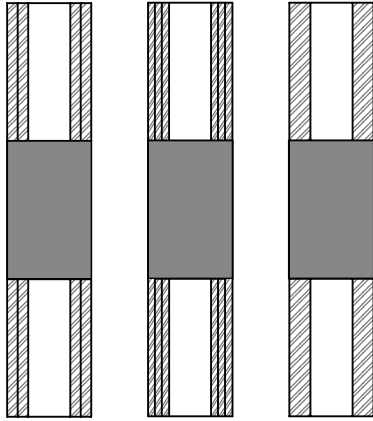

Rigid walls with a density of $\geq 350 \text{ kg/m}^3$

e.g.:

