

Products & Solutions

Shaped for the shipbuilding and offshore market

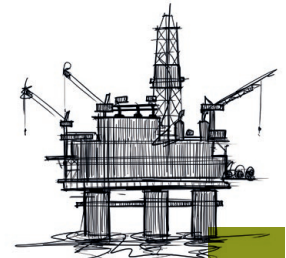

SeaRox

Marine & Offshore
Insulation

Technical insulation

shaped by experts



We share our knowledge to your advantage

ROCKWOOL Technical Insulation – part of the ROCKWOOL International Group – offers innovative technical insulation solutions for the process & power generation industry and the shipbuilding & offshore market worldwide.

To that end, we have subsumed our product range into two specialist categories. SeaRox comprises the full marine and offshore range and ProRox covers all our insulation solutions for the process industry and for onboard and offshore technical installations. Through our two product lines, our experts offer a full spread of products and systems guaranteeing the highest possible thermal, acoustic and fire-safe insulation for all kinds of technical installations.

We have more than 80 years' experience, reflected in a complete set of high-grade products and expert advice. We remain fully committed to providing the very best service on the market and a complete range of cutting-edge insulation solutions.

For many years we have been one of the biggest suppliers in shipbuilding and offshore. As part of our global strategic approach we offer a uniform, transparent and harmonized product range throughout the world – from the United Kingdom to China. This is essential in the marine and offshore industry. It makes it easier for you to ensure you have the right material in your own country and for your international projects across the border.

All our products and solutions in a blink of an eye

This is a practical guide presenting our expertise on the marine and offshore market. Your market. We provide information about our latest products and solutions, made to meet all your insulation needs.

We show you how our new generation lightest stone wool solutions (SeaRox FB 6000 and FM 6000 product ranges) opens up new design possibilities. We present our thin SeaRox SL 620 slabs and tell you how they improve workability without compromising on fire safety and acoustic comfort. And, last but not least, we give you more insight into how our solutions can help you perform better, and overcome such challenges as corrosion under insulation.

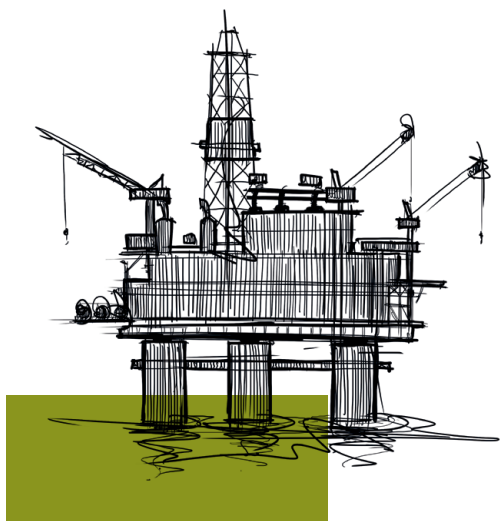

Overview of products **5**

Lightweight fire-safe solutions **6**

Optimized standard solutions **9**

More than just insulation **10**

A- & H- Constructions **12**

Additional fire protection **18**

Sound insulation **20**

Thermal and comfort insulation **22**

Floating floor & panels **23**

Technical insulation **24**

Product selector **28**

Product overview **29**

“SeaRox” - what’s in a name?

Our customers operate all over the globe. We therefore offer them a uniform, transparent product range that matches and meets their requirements throughout the world – from the UK to China, from India to Brazil. It's only logical that we came up with a clear and consistent nomenclature for our SeaRox products. Our universal product coding makes it even easier to find the exact product you need, wherever you are working.

Each product name is structured in the same clear way:

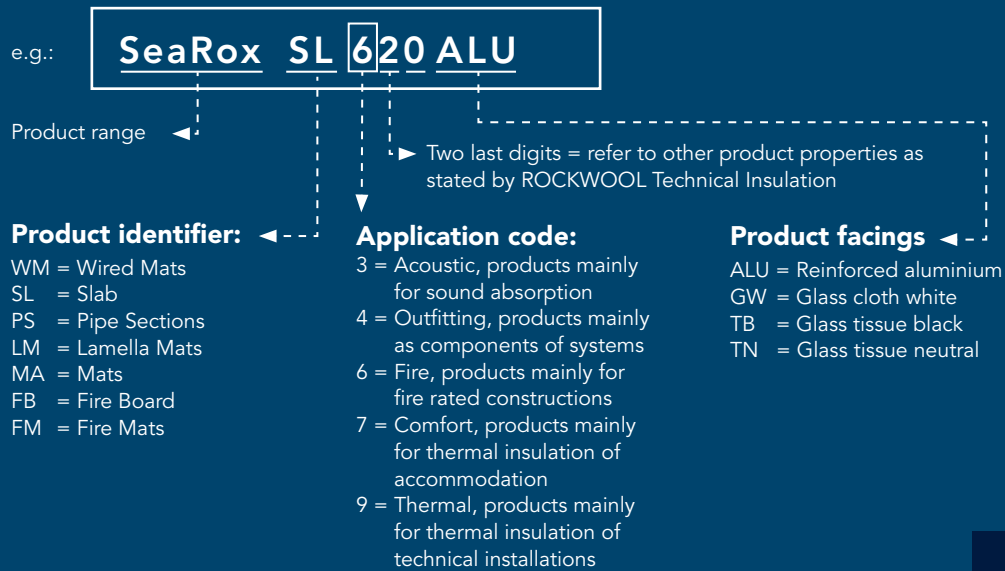

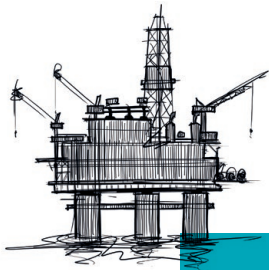

SeaRox

Marine & Offshore insulation

Under the SeaRox name we market a full range of fire-safe solutions for the shipbuilding industry that also offer optimal acoustic and thermal insulation as well as solutions for insulation of onboard technical installations.

The key property of all these products is outstanding thermal insulation, which helps keep energy consumption under control. Naturally, they also meet the most stringent demands with respect to acoustic insulation and fire resistance. We have fine-tuned our marine and offshore range, too, bearing in mind the increasing necessity for an efficient, clear product offering.

Overview of products

Comfort insulation

- SeaRox MA 7000 ALU 29
- SeaRox SL 720 29
- SeaRox MA 720 ALU 29
- SeaRox SL 740 29
- SeaRox MA 740 ALU 29

Acoustic insulation

- SeaRox SL 320 29
- SeaRox SL 340 29
- SeaRox Acoustic Foil 29

Outfitting insulation

- SeaRox SL 436 29
- SeaRox SL 440 29
- SeaRox SL 480 29

Fire-safe insulation

- SeaRox FB 6020 30
- SeaRox FB 6040 30
- SeaRox FB 6050 30
- SeaRox FM 6030 ALU 30
- SeaRox FM 6040 ALU 30
- SeaRox FM 6050 ALU 30
- SeaRox SL 620 30
- SeaRox SL 640 30
- SeaRox SL 660 30
- SeaRox WM 620 30
- SeaRox WM 640 30
- SeaRox WM 660 30

Technical insulation

- SeaRox LM 900 ALU 31
- ProRox WM 950 31
- ProRox PS 960 31
- ProRox PS 960 ALU 31

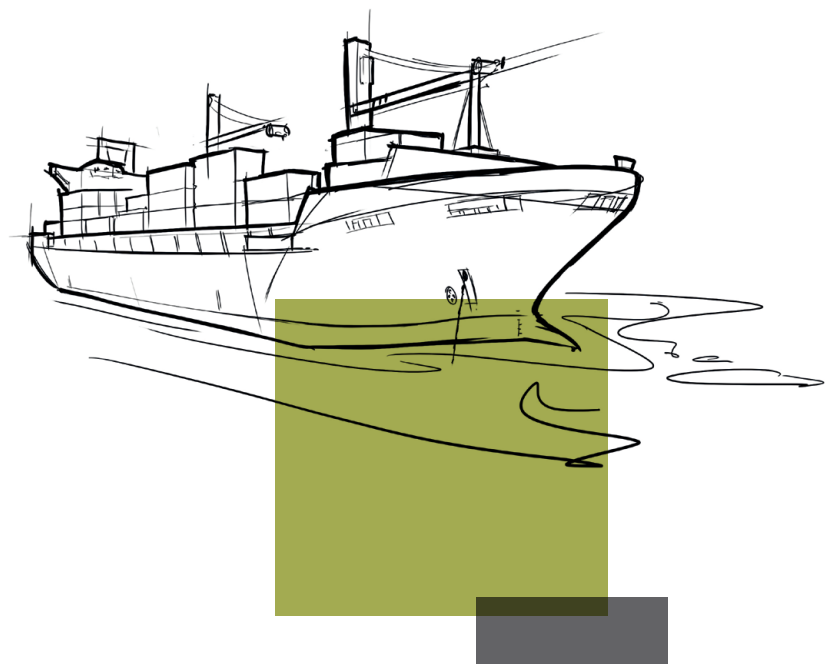

Lightweight fire-safe solutions

New generation SeaRox

Economic and ecological pressures on the shipbuilding and offshore industry worldwide are playing a dominant role in its energy consumption and environmental impact.



SeaRox FB 6000 - Fire Board range

The commitment to a sustainable approach has become an increasingly prominent item on the agenda of shipowners, shipbuilders, naval architects and marine engineers. This includes safety, environmental protection, efficient operation and resource conservation.

Energy-efficiency measures also address the reduction of carbon emissions from international shipping; a key factor in ensuring international shipping contributes to efforts to mitigate climate change. Efforts to control energy consumption are likely to drive incremental efficiency improvement.

At ROCKWOOL Technical Insulation, we meet this challenge with a new range of high-performance lightweight stone wool solutions: the product ranges of SeaRox FB 6000 fire board and SeaRox FM 6000 fire mat .

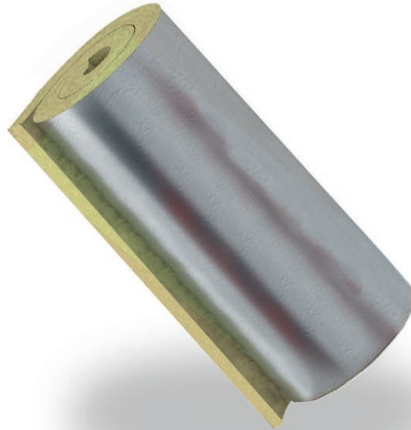

SeaRox FM 6000 - Fire Mat range

These new generation SeaRox products combine the solid product performance in fire, thermal and acoustic insulation of ROCKWOOL stone wool at an exceptionally low weight.

Flexible properties

One of the characteristics of our new product range is the new look and feel compared to our traditional range of SeaRox fire protection products. They continue to be delivered in the practical dimensions of slabs and mats but due to the optimized production process and reduced density the materials are softer and more flexible.

The SeaRox FB 6000 and FM 6000 range...

- new design possibilities...



Greater flexibility to design the right insulation solution

The introduction of the SeaRox FM 6000 fire mats extends the range of lightweight insulation designs.

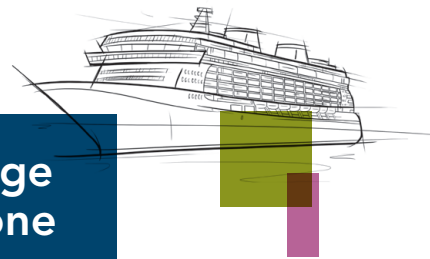

A complete range for improved workability and faster installation

Following the success of our lightweight SeaRox FB 6000 range, we have introduced the SeaRox FM 6000 series of lightweight fire mats. This novel combination opens up new design possibilities.

Optimized pin design

We have developed a simple, uniform pin design for all products as part of our new optimized solutions. We have also reduced the number of pins on the steel plate by up to 20%, cutting the installation time. All our SeaRox fire mat solutions are tested and approved with no pin on stiffeners to ensure faster, safer installation.

Solutions certified by major classification bodies

Our new ROCKWOOL Technical Insulation lightweight solutions are **MED-approved by DNV**, with additional certification by other major classification bodies. New certificates are issued for all new solutions, specifying the product and clearly describing the alternative design.

Our latest certificates are published at rti.rockwool.com

The complete range of lightweight stone wool products...

The SeaRox FB 6000 range comprises exceptionally lightweight flexible stone wool fire boards. The SeaRox FM 6000 range consists of lightweight fire mats, delivered with reinforced aluminium foil on one side as standard. This range is specially designed to optimize the insulation speed of stiffeners in general and facilitate installation of deck constructions as one-layer solutions.

Today, the complete range of lightweight stone wool products for fire insulation of A-Class divisions consists of:

SeaRox FM 6000 series:

- SeaRox FM 6030 ALU: 30 mm, 50 kg/m³
- SeaRox FM 6040 ALU: 35 and 50 mm, 60 kg/m³
- SeaRox FM 6050 ALU: 75 mm, 70 kg/m³

SeaRox FB 6000 series:

- SeaRox FB 6020: 70 mm, 40 kg/m³
- SeaRox FB 6040: 35 and 70 mm, 60 kg/m³
- SeaRox FB 6050: 30 and 75 mm, 70 kg/m³



NEW
lightweight constructions for aluminium structures

The new lightweight ROCKWOOL Technical Insulation solutions are tested according to the latest IMO 2010 FTP Code.

Type 1. Standard design – SeaRox FB 6000 range

Advantages:

- Easy handling – standard slab dimensions
- Softer and more flexible slabs

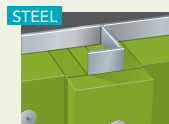

Type 2. Hybrid solution - SeaRox FB+FM 6000 ranges, alternative 1

Advantages:

- Fast installation
- Suitable for narrow spaces
- Safer (no pin on stiffeners)
- Reduced cut-off waste

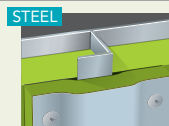

Type 3. Hybrid solution - SeaRox FB+FM 6000 ranges, alternative 2

Advantages:

- Fast installation
- No open gaps
- Reduced cut-off waste

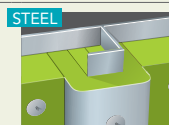

Type 4. SeaRox FM 6000 ALU series solutions

Advantages:

- Fast installation
- Reduced cut-off waste
- One-layer solution possible

Note: Only for A30 and A60 Deck application

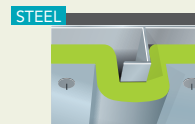

Type 5. No insulation on stiffeners

Advantages:

- Fast installation (no insulation on stiffeners)
- Thin solution (no insulation on stiffeners)

Note: Only for A15 application



Type 6. SeaRox FM 6000 ALU range in one or two layers

Advantages:

- Fast installation
- Just one product in one size

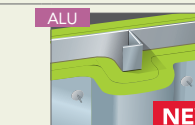

NEW
lightweight A-60 solutions for 4 mm aluminium bulkhead and deck



Advantages NEW SeaRox SL 620 at a glance:

- **Thin stone wool bulk solutions** for steel bulkhead and deck fulfilling with highest level of safety
- **Highest fire safety** – IMO 2010 FTP Code part 3
- **Improved acoustic performance** – ISO 10140-2 and ISO 717-1
- **Cost competitive** bulk solutions
- **Updated certificates** from major classification bodies
- **Future-proof** solution – no limitation in renewal of certificates
- All major constructions covered with a **limited number of variations** – one product, four dimensions
- **Limited stock needed**
- **Specification texts** ready for use
- **Low water absorption** maintaining thermal performance and reducing the risk of CUI

Optimized standard solutions

NEW SeaRox SL 620 meets the need for better solutions

Having a thin slab with the best fire safety contributes to a safe environment for people in all temperature conditions onboard ships and offshore. The improved acoustic performance contributes to a comfortable environment for all crew and passengers.

In many cases, low weight is not the main driver. With that in mind we now offer a superior set of standard solutions with thin insulation thicknesses, improved acoustic performance and the highest fire safety according to IMO 2010 FTP Code. All solutions are based on new, improved SeaRox SL 620.

The thin insulation thicknesses ensures better installation with higher operational efficiency.

This SeaRox SL 620 innovation results in cost efficient A-class steel divisions.



Complete range A-class steel divisions

Most competitive bulk assortment world wide

Construction		Product	Thickness	
			Plate	Stiffener
A15	Bulkhead	SeaRox SL 620	50	
A15	Deck	SeaRox SL 620	50	
A30	Bulkhead	SeaRox SL 620	40	25
A30	Deck	SeaRox SL 620	25	25
A60	Bulkhead	SeaRox SL 620	60	25
A60	Bulkhead restricted	SeaRox SL 620	40	25
A60	Deck	SeaRox SL 620	40	25

High acoustic performance

Sound reduction performance on SeaRox SL 620

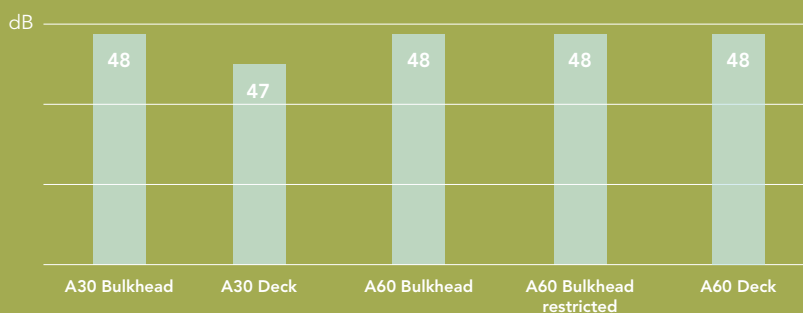

Acoustic measurements are conducted according to ISO 1040-2 and ISO 717-1 on 6 mm steel plate.

Green Passport

(Hong Kong International Convention)
In recent years we have seen increased focus on health and safety onboard. In response, Green Passports have been introduced according to IMO Res A.980 (24).

The Green Passport is a single document for each vessel listing all the potentially hazardous materials onboard as stated in the Inventory of Hazardous Materials Resolution MEPC.269(68). This document stays with the ship throughout its life until it is decommissioned and sent to the ship breaking yard.

None of our ROCKWOOL Technical Insulation stone wool products for the marine and offshore market produced at any ROCKWOOL production plant will be classified as hazardous or potentially hazardous material under the abovementioned IMO resolution (MEPC.269(68) Tables A, B and C). ROCKWOOL insulation therefore has no impact on the inventory of hazardous material.



More than just insulation

Certificates and documentation

All SeaRox products and constructions have been tested according to the latest IMO regulations and approved by all major classification societies, and additionally certified according to the latest MED directive (EU directive 2014/90/EU - Marine Equipment Directive).

References

ROCKWOOL Technical Insulation has been active in the marine and offshore industry worldwide for the past 30 years.

In recent years our material has been frequently used in all kinds of projects, including:

- Commercial ships
- Passenger vessels and cruise liners
- Yachts
- Navy ships
- Platforms and accommodation units

Technical service

IMO and other marine authorities and classification societies constantly update their passive fire protection, noise reduction and thermal insulation regulations. With our high-level technical support, we are able to help our customers choose the optimal solution and secure the necessary documentation.

Research and development

We capitalize on the ROCKWOOL Group's intensive research and developments efforts to constantly improve and enhance our products and services in line with customer wishes and needs, both today and in the future.



Health and safety

All our ROCKWOOL SeaRox products are made of fibers complying with the Note Q criteria of the European Union regulations on classification, labelling and packaging of substances and mixtures (EC No 1272/2008 and No 790/2009) and so are not classified as hazardous. This is certified by EUCEB (www.EUCEB.org). Additionally, all our ROCKWOOL SeaRox products are asbestos-free.

Find all the documents you need for your marine & offshore projects

Check out the new SeaRox Document Finder.

We have integrated an easy-to-use search tool into the international SeaRox Marine & Offshore website.











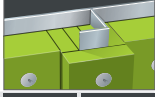



Use the SeaRox Document Finder to find all the documents you need for your projects, quickly and conveniently. Including type approvals, product datasheets and drawings.

Simply add what you need to your basket and download as a zip file or forward by email. You no longer need to trawl through the whole website to find your documents.

Visit us at rti.rockwool.com

A-Constructions (steel)

LIGHTWEIGHT SOLUTIONS

Fire Class	Design	Products	Thickness (mm)	Density (kg/m ³)	Weight (kg/m ²)	Thermal conductivity (W/mK) at 10°C mean temp	U-value plate product (W/m ² K)	Weighted sound absorption (plate product)	Weighted sound reduction R _w (dB)
Steel Bulkhead									
A15 Bulkhead		Slab	Plate: SeaRox FB 6040	35	60	1.3	0.034	0.97	45
			Stiffener: No insulation						
A30 Bulkhead		Slab	Plate: SeaRox FB 6020	70	40	2.5	0.034	0.49	0.95
			Stiffener: SeaRox FB 6050	30	70				
A30 Bulkhead		Slab/Mat	Plate: SeaRox FB 6020	70	40	2.3	0.034	0.49	0.95
			Stiffener: SeaRox FM 6030 ALU	30	50				
A60 Bulkhead		Slab	Plate: SeaRox FB 6040	70	60	3.4	0.034	0.49	0.90
			Stiffener: SeaRox FB 6050	30	70				
A60 Bulkhead		Slab/Mat	Plate: SeaRox FB 6040	70	60	3.4	0.034	0.49	0.90
			Stiffener: SeaRox FM 6040 ALU	35	60				
A60 Bulkhead restricted		Slab	Plate: SeaRox FB 6020	70	40	2.5	0.034	0.49	0.95
			Stiffener: SeaRox FB 6050	30	70				
A60 Bulkhead restricted		Slab/Mat	Plate: SeaRox FB 6020	70	40	2.5	0.034	0.49	0.95
			Stiffener: SeaRox FM 6040 ALU	35	60				
Steel Deck									
A15 Deck		Slab	Plate: SeaRox FB 6020	70	40	1.7	0.034	0.49	45
			Stiffener: No insulation						
A15 Deck		Slab	Plate: SeaRox FB 6040	35	60	1.3	0.034	0.97	45
			Stiffener: No insulation						
A30 Deck		Slab	Plate: SeaRox FB 6050	30	70	2.1	0.034	1.13	0.55
			Stiffener: SeaRox FB 6050	30	70				
A30 Deck		Mat	Plate: SeaRox FM 6030 ALU	30	50	1.5	0.034	1.13	46
			Stiffener: SeaRox FM 6030 ALU	30	50				
A30 Deck		Slab/Mat	Plate: SeaRox FB 6050	30	70	1.9	0.034	1.13	0.55
			Stiffener: SeaRox FM 6030 ALU	30	50				
A60 Deck		Slab	Plate: SeaRox FB 6020	70	40	2.5	0.034	0.49	0.95
			Stiffener: SeaRox FB 6050	30	70				
A60 Deck		Mat	Plate: SeaRox FM 6040 ALU	50	60	3,0	0.034	0.68	47
			Stiffener: SeaRox FM 6040 ALU	50	60				
A60 Deck		Slab/Mat	Plate: SeaRox FB 6020	70	40	2.5	0.034	0.49	0.95
			Stiffener: SeaRox FM 6040 ALU	35	60				



STANDARD SOLUTIONS

Fire Class	Design	Products	Thickness (mm)	Density (kg/m ³)	Weight (kg/m ²)	Thermal conductivity (W/mK) at 10°C mean temp	U-value plate product (W/m ² K)	Weighted sound absorption (plate product)	Weighted sound reduction Rw (dB)
------------	--------	----------	-------------------	---------------------------------	--------------------------------	--	---	---	---

Steel Bulkhead

A15 Bulkhead		Slab	Plate: SeaRox SL 620 Stiffener: No insulation	50	100	3.0	0.035	0.70	0.85
A30 Bulkhead		Slab	Plate: SeaRox SL 620 Stiffener: SeaRox SL 620	40 25	100 100	3.4	0.035	0.88	0.80
A60 Bulkhead		Slab	Plate: SeaRox SL 620 Stiffener: SeaRox SL 620	60 25	100 100	4.6	0.035	0.58	0.90
A60 Bulkhead restricted		Slab	Plate: SeaRox SL 620 Stiffener: SeaRox SL 620	40 25	100 100	3.4	0.035	0.88	0.80

Steel Deck

A15 Deck		Slab	Plate: SeaRox SL 620 Stiffener: No insulation	50	100	3.0	0.035	0.70	0.85
A30 Deck		Slab	Plate: SeaRox SL 620 Stiffener: SeaRox SL 620	25 25	100 100	2.5	0.035	1.40	47
A60 Deck		Slab	Plate: SeaRox SL 620 Stiffener: SeaRox SL 620	40 25	100 100	3.4	0.035	0.88	0.80

CORRUGATED BULKHEAD SOLUTIONS

Fire Class	Design	Products	Thickness (mm)	Density (kg/m ³)	Weight (kg/m ²)	Thermal conductivity (W/mK) at 10°C mean temp	U-value plate product (W/m ² K)	Weighted sound absorption (plate product)	Weighted sound reduction Rw (dB)
------------	--------	----------	-------------------	---------------------------------	--------------------------------	--	---	---	---

A60 Corr. Bulkhead (2 mm)		Slab	Plate: SeaRox SL 620	50 + 30	100	8.0	0.035	0.43	
A60 Corr. Bulkhead (4 mm)		Slab	Plate: SeaRox SL 620	50 + 30	100	8.0	0.035	0.43	

Estimated weight based on 1 sqm. Insulation split: 60% steel plate, 40% stiffener insulation.
Acoustic measurements are conducted according to ISO 10140-2 and ISO 717-1 on 6 mm steel plate.

A-Constructions (steel)

FLOATING FLOOR SOLUTIONS





Fire Class	Design	Products	Thickness (mm)	Density (kg/m ³)	Weight (kg/m ²)	Thermal conductivity (W/mK) at 10°C mean temp	U-value plate product (W/m ² K)	Weighted sound absorption (plate product)	Weighted sound reduction R _w (dB)
------------	--------	----------	-------------------	---------------------------------	--------------------------------	--	---	---	---

A60	Floating Floor		Slab	SeaRox SL 436, 440, 480	60*	140 - 200	0.037	0.62	
-----	----------------	---	------	-------------------------	-----	-----------	-------	------	--

* (+ 2 x 1.5 mm glued steel top plate)

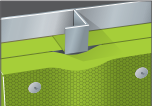
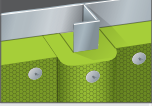
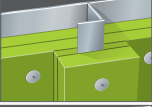
NON-STANDARD SOLUTIONS



Fire Class	Design	Products	Thickness (mm)	Density (kg/m ³)	Weight (kg/m ²)	Thermal conductivity (W/mK) at 10°C mean temp	U-value plate product (W/m ² K)	Weighted sound absorption (plate product)	Weighted sound reduction R _w (dB)
------------	--------	----------	-------------------	---------------------------------	--------------------------------	--	---	---	---

A60	Bulkhead		Wired Mat	Plate: SeaRox WM 620	2 x 45	90	6.5	0.035	0.39	0.95	49
				Stiffener: SeaRox WM 620	45	90					
A60	Bulkhead		Wired Mat	Plate: SeaRox WM 640	75	105	6.0	0.036	0.48	0.90	47
				Stiffener: SeaRox WM 640	30	105					
A60	Bulkhead		Slab	Plate: SeaRox SL 640	2 x 30	130	6.2	0.037	0.62	0.90	48
				Stiffener: SeaRox SL 640	30	130					
A60	Bulkhead restricted		Slab	Plate: SeaRox SL 640	40	130	5.2	0.037	0.93	0.80	45
				Stiffener: SeaRox SL 640	40	130					
A60	Deck		Wired Mat	Plate: SeaRox WM 620	45	90	4.1	0.035	0.78	0.90	46
				Stiffener: SeaRox WM 620	45	90					
A60	Deck		Slab	Plate: SeaRox SL 640	40	130	5.2	0.037	0.93	0.80	
				Stiffener: SeaRox SL 640	40	130					

Estimated weight based on 1 sqm. Insulation split: 60% steel plate, 40% stiffener insulation.
Acoustic measurements are conducted according to ISO 10140-2 and ISO 717-1 on 6 mm steel plate.

A-Constructions (aluminium)

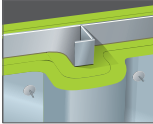
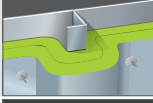
LIGHTWEIGHT SOLUTIONS

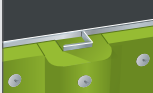
Fire Class	Design	Products	Thickness (mm)	Density (kg/m ³)	Weight (kg/m ²)	Thermal conductivity (W/mK) at 10°C mean temp	U-value plate product (W/m ² K)	Weighted sound absorption (plate product)	Weighted sound reduction Rw (dB)
Alu Bulkhead									
A60	Bulkhead 6mm	 Plate: SeaRox FM 6040 ALU Insulation on both sides of the alu plate	2 x 35	60	8.4	0.034	0.49		46
		Stiffener: SeaRox FM 6040 ALU	2 x 35	60					
A60	Bulkhead restricted 6mm	 Plate: SeaRox FM 6040 ALU	2 x 35	60	4.2	0.034	0.49		43
		Stiffener: SeaRox FM 6040 ALU	2 x 35	60					
NEW	A60 Bulkhead 4mm	 Plate: SeaRox FM 6050 ALU Insulation on both sides of the alu plate	75	70	10.6	0.034	0.45		41
		Stiffener: SeaRox FM 6050 ALU	75	70					
NEW	A60 Bulkhead restricted 4mm	 Plate: SeaRox FM 6050 ALU	75	70	5.3	0.034	0.45		39
		Stiffener: SeaRox FM 6050 ALU	75	70					

* alternative product SeaRox FB 6050

Alu Deck

A60	Deck 6mm	 Plate: SeaRox FM 6040 ALU	2 x 35	60	4.2	0.034	0.49		43
		Stiffener: SeaRox FM 6040 ALU	2 x 35	60					
NEW	A60 Deck 4mm	 Plate: SeaRox FM 6050 ALU	75	70	5.3	0.034	0.45		39
		Stiffener: SeaRox FM 6050 ALU	75	70					

* alternative product SeaRox FB 6050

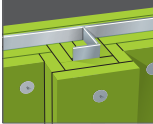
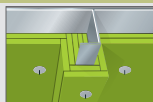

STANDARD SOLUTIONS

Fire Class	Design	Products	Thickness (mm)	Density (kg/m ³)	Weight (kg/m ²)	Thermal conductivity (W/mK) at 10°C mean temp	U-value plate product (W/m ² K)	Weighted sound absorption (plate product)	Weighted sound reduction Rw (dB)
Alu Bulkhead									
A60	Bulkhead 6mm	 Plate: SeaRox SL 620 Insulation on both sides of the alu plate	2 x 30	100	12.0	0.035	0.58		40
		Stiffener: SeaRox SL 620	2 x 30	100					
Alu Deck									
A60	Deck 6mm	 Plate: SeaRox SL 620	2 x 30	100	6.0	0.035	0.58		40
		Stiffener: SeaRox SL 620	2 x 30	100					

Estimated weight based on 1 sqm. Insulation split: 60% steel plate, 40% stiffener insulation.
Acoustic measurements are conducted according to ISO 10140-2 and ISO 717-1 on 6 mm steel plate.

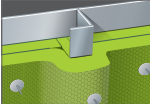
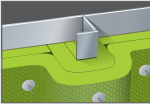
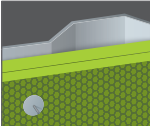
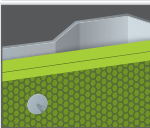

H-Constructions (steel)

Fire Class	Design	Products	Thickness (mm)	Density (kg/m ³)	Weight (kg/m ²)	Thermal conductivity (W/mK) at 10°C mean temp	U-value plate product (W/m ² K)	Weighted sound absorption (plate product)	Weighted sound reduction Rw (dB)
Steel Bulkhead									
H60 Bulkhead restricted		Slab/ WM	Plate: SeaRox SL 660 SeaRox WM 660	30 + 40	150	8.7	0.037	0.53	48
			Stiffener: SeaRox WM 660	40	150				
H120 Bulkhead restricted		Slab/ WM	Plate: SeaRox SL 660 SeaRox WM 660	30 + 40	150	11.1	0.037	0.53	49
			Stiffener: SeaRox WM 660	2 x 40	150				
H60 Non load bearing, corr. steel restricted		Slab	Plate: SeaRox SL 660 SeaRox WM 660	50 + 40	150	13.5	0.037	0.41	44
H120 Non load bearing, corr. steel restricted		Slab	Plate: SeaRox SL 660 SeaRox WM 660	50 + 40	150	13.5	0.037	0.41	44
Steel Deck									
H60 Deck		Slab	Plate: SeaRox SL 660	2 x 50	150	15.0	0.037	0.37	48
			Stiffener: SeaRox SL 660	2 x 50	150				

Estimated weight based on 1 sqm. Insulation split: 60% steel plate, 40% stiffener insulation.
Acoustic measurements are conducted according to ISO 10140-2 and ISO 717-1 on 6 mm steel plate.

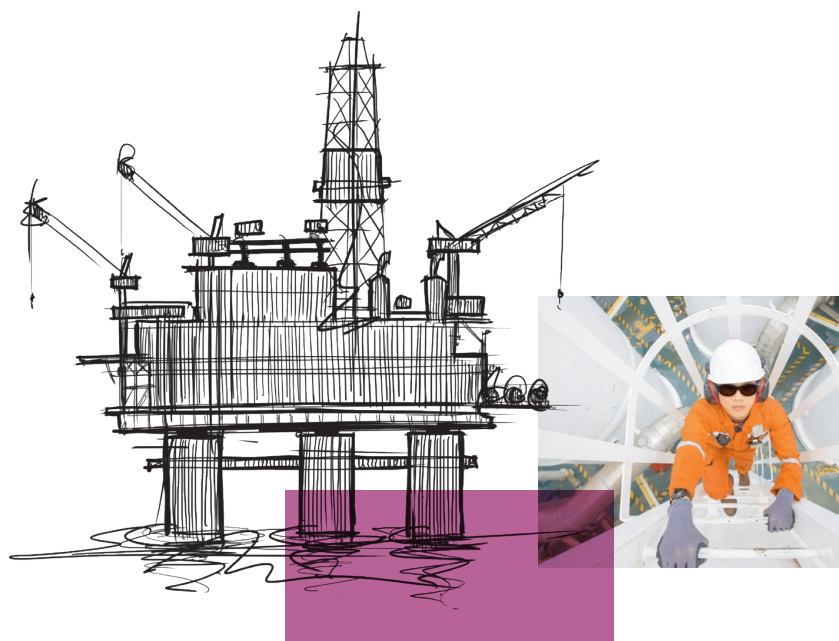

Additional fire protection

A-60 fire-rated solutions for corrugated steel

In some projects and applications the standard IMO structural core is replaced with a light structural core consisting of a corrugated steel plate.

Corrugated steel plate is often used to obtain a lighter structure for offshore living quarters, firewalls or containers.

The market is characterized by a range of different steel designs with their own corrugation geometry and steel thicknesses and there is no standard fire test procedure. At ROCKWOOL Technical Insulation we have passed two A-60 unrestricted fire-rated design tests for corrugated steel plate.

One has a 2 mm corrugated steel plate and the other a 4.5 mm corrugated steel plate. Both solutions have been tested and approved according to IMO 2010 FTP Code part 3, fire on either side.

Solutions have been tested and approved based on SeaRox SL 620, 50 + 30 mm without filling the voids. Alternative design needs should be approved by a local surveyor.

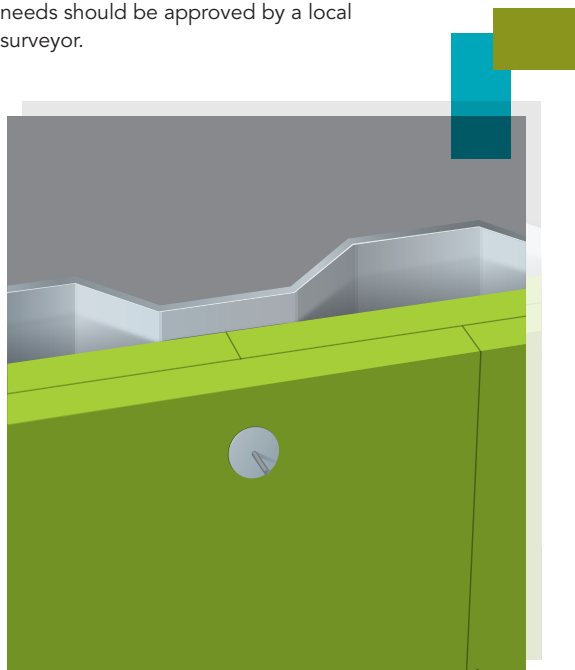

The advantages of the solutions:

- Tested according to the latest fire test procedure, IMO 2010 FTP Code
- MED-certified by Det Norske Veritas
- Easy installation – no filling of voids
- Test of alternative structural design from 2 mm to 4.5 mm



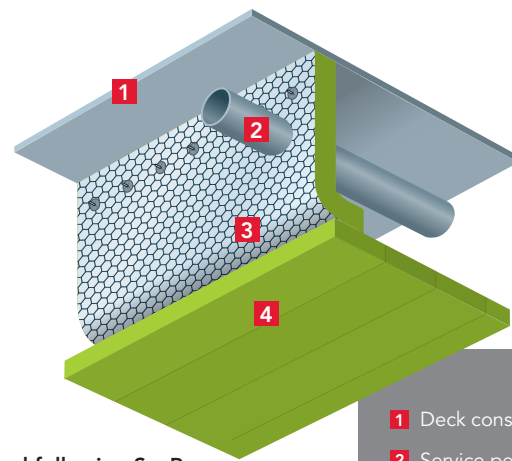

- 1 Deck construction
- 2 Service penetration
- 3 Cut around penetration and wire mesh stitched together along joint
- 4 Suspended ceiling

Draught stops

Draught stops are divisions between ceilings or linings and the ship's structure. The purpose of draught stops is to prevent the spread of smoke and flame in concealed spaces.

There are several ways to design and construct draught stops, depending on the actual vessel design and requirements. A key minimum requirement is that they are made from non-combustible materials and fulfil the requirements of a "C class" division. Occasionally there will also be requirements for B-0 class draught stops.

We recommend following SeaRox insulation solutions: B-0 class draught stops:

Construction

- SeaRox WM 640, min. 50 mm, with reinforced aluminium foil or
- SeaRox SL 620, min. 50 mm, with reinforced aluminium foil.

Insulation fixed with $\varnothing 3$ mm pins and secured with $\varnothing 38$ mm washers. If SeaRox SL 620 is used, it must be fitted with wire mesh on the side where the washers are applied and the insulation fixed.

Penetrations

Penetrations of fire divisions

Penetrations are where pipes, ducts and so on go through a bulkhead or deck.

To ensure the penetration does not compromise the fire division, it must be protected, by a penetration seal say, and the solution must be tested in accordance with the IMO 2010 FTP code. Testing is not required if the pipe penetration is made of steel with a thickness of 3 mm or greater and a length of not less than 900 mm (preferably 450 mm on each side of the division) and there are no openings (meaning the pipe needs to be welded to the steel bulkhead/deck plate). Such penetrations must be suitably insulated by extending the insulation to the same level as the division.

ROCKWOOL recommends the following SeaRox insulation solutions for pipe penetrations of A class steel divisions with no openings:

Construction

- SeaRox WM 620, min. 45 mm, the wire mesh should be twisted together at joints.
- SeaRox FM 6040 ALU, min. 50 mm, steel bands or galvanized steel wires (min. $\varnothing 0.7$ mm) must be fitted circumferentially to the system – at least 2x per 450 mm of insulation to ensure all joints and grooves remain tightly closed.

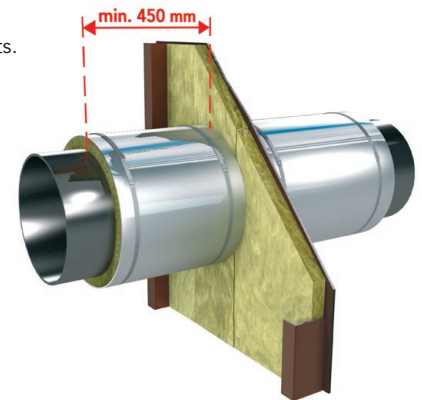

Sound insulation

When people are exposed to consistently elevated noise levels, their health may be affected. Elevated workplace or environmental noise can cause hearing impairment, hypertension, heart diseases, annoyance and sleep disturbance. Beyond these effects, elevated noise levels can create stress and increase workplace accident rates. To improve safety onboard ships, the new IMO noise code – resolution MSC.337(91) – implemented in 2014 introduced new mandatory requirements for the noise reduction measures on ships; the design, documentation and performance, as well as actual noise levels onboard. These requirements must be complied with, in addition to possible comfort class requirements or requirements from the flag state.

The acoustics on ships are quite complex, often with multiple noise sources, a metal hull that transmits the noise and space constraints requiring people to work and rest close to the sources. Sound design work, calculations and final onboard measurements generally demand acoustic engineers with specialist skills.

ROCKWOOL SeaRox products have excellent properties as sound absorbers, stopping structure-borne noise (i.e. in floating floor and bulkhead constructions) and as noise reducers in panelling.

We have conducted a large range of basic product measurements to produce the data needed by acoustic engineers for their calculations. The noise reduction capabilities of a number of typical constructions have also been tested. See the list opposite and the ROCKWOOL Acoustic Manual for more details.

If noise emission from pipelines is an issue, see the ROCKWOOL Acoustic solutions for pipework.



Sound absorption is a material property that describes how well sound waves are absorbed by a material.

Absorption measurements

No	Products	Weighted absorption α_w
1	SeaRox FB 6020, 70 mm	0.95
2	SeaRox FB 6040, 70 mm	0.90
3	SeaRox FB 6050, 30 mm	0.55
4	SeaRox SL 620, 40 mm	0.80
5	SeaRox SL 620, 40 mm + alu foil	0.50
6	SeaRox SL 620, 60 mm incl. pin's and washer	0.90
7	SeaRox SL 620, 60 mm incl. pin's and washer, covered by 19 μ foil	0.90
8	SeaRox SL 320, 50 mm	0.85
9	SeaRox SL 340, 50 mm	0.90
10	SeaRox SL 740, 50 mm	0.75
11	SeaRox SL 340, 2 x 50 mm	0.95
12	SeaRox SL 740, 50 mm + alu foil	0.65
13	SeaRox SL 436, 50 mm	0.85
14	SeaRox SL 440, 50 mm	0.75
15	SeaRox SL 480, 50 mm	0.75
16	SeaRox SL 480, 2 x 30 mm	0.80
17	SeaRox SL 640, 30 mm	0.70
18	SeaRox SL 640, 2 x 30 mm	0.90
19	SeaRox SL 660, 2 x 50 mm	0.90
20	SeaRox WM 950, 50 mm	0.90
21	SeaRox WM 950 ALU, 50 mm	0.90
22	SeaRox WM 950, 100 mm	0.70
23	SeaRox WM 950 ALU, 100 mm	0.95
24	SeaRox WM 620, 45 mm	0.90
25	SeaRox WM 620, 45 mm + SeaRox Acoustic Foil (19 μ) + perf. steel plate (suspended)	0.90
26	SeaRox WM 620, 2 x 45 mm	0.95
27	SeaRox WM 640, 30 mm	0.80
28	SeaRox WM 640, 75 mm	0.90
29	SeaRox WM 640, 100 mm	0.90

SeaRox Acoustic Foil system especially designed for sound absorption in engine rooms

- Optimal sound properties
- Resistant to oil/oil mist
- Tested and approved
- Easy installation

- Steel plate
- SeaRox insulation
- SeaRox Acoustic Foil
- Perforated steel plate

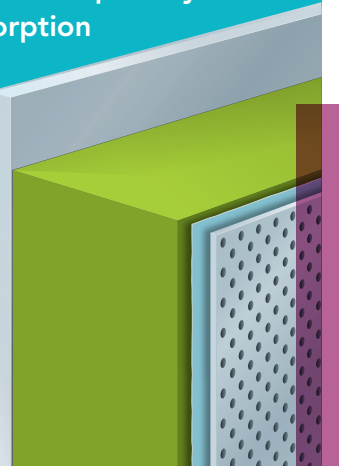

Sound reduction
is an impression rating the reduction
of sound through a wall or a building
element from one room to the other.

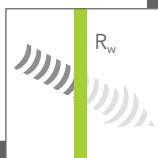
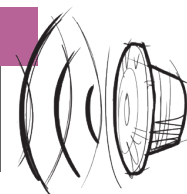

Reduction measurements

No	Construction	Products	Weighted reduction R_w
1	A15 steel deck	SeaRox FB 6020, 70 mm (no insulation on stiffeners)	45 dB
2	A15 steel deck and bulkhead	SeaRox FB 6040, 35 mm (no insulation on stiffeners)	45 dB
3	A30 steel bulkhead	SeaRox FB 6020, 70 mm / SeaRox FB 6050, 30 mm	46 dB
4	A30 steel bulkhead + thermal	SeaRox FB 6020, 70 mm / SeaRox FB 6050, 30 mm and 50 mm SeaRox MA 720 ALU	49 dB
5	A30 steel bulkhead	SeaRox FB 6020, 70 mm / SeaRox FM 6030 ALU, 30 mm	46 dB
6	A30 steel deck	SeaRox FB 6050, 30 mm / SeaRox FM 6050, 30 mm	45 dB
7	A30 steel deck	SeaRox FM 6030 ALU, 30 mm / SeaRox FM 6030 ALU, 30 mm	46 dB
8	A30 steel deck	SeaRox SL 620, 40 mm / 25 mm and 50 mm SeaRox MA 720 ALU	50 dB
9	A30 steel deck	SeaRox SL 620, 25 mm / 25 mm	47 dB
10	A60 steel bulkhead	SeaRox FB 6040, 70 mm / SeaRox FB 6050, 30 mm	48 dB
11	A60 steel bulkhead	SeaRox FB 6040, 70 mm / SeaRox FM 6040, 35 mm	48 dB
12	A60 steel bulkhead	SeaRox SL 620, 60 mm / 25 mm	48 dB
13	A60 steel bulkhead + thermal	SeaRox SL 620, 60 mm / 25 mm and 50 mm SeaRox MA 720 ALU	49 dB
14	A60 steel bulkhead + thermal	SeaRox FB 6040, 70 mm / SeaRox FB 6050, 30 mm and 50 mm SeaRox MA 720 ALU	50 dB
15	A60 steel bulkhead restr.	SeaRox FB 6020, 70 mm / SeaRox FB 6050, 30 mm	46 dB
16	A60 steel bulkhead restr.	SeaRox FB 6020, 70 mm / SeaRox FM 6040 ALU, 35 mm	46 dB
17	A60 steel bulkhead restr. + thermal	SeaRox FB 6020, 70 mm / SeaRox FB 6050, 30 mm and 50 mm SeaRox MA 720 ALU	49 dB
18	A60 steel deck	SeaRox FB 6020, 70 mm / SeaRox FB 6050, 30 mm	46 dB
19	A60 steel deck	SeaRox FM 6040 ALU, 50 mm / SeaRox FM 6040 ALU, 50 mm	47 dB
20	A60 steel deck	SeaRox FB 6020, 70 mm / SeaRox FM 6040 ALU, 35 mm	46 dB
21	A60 steel deck	SeaRox SL 620, 40 mm / 25 mm	48 dB
22	H60 steel bulkhead restricted	SeaRox SL 660, 30 mm and SeaRox WM 660, 40 mm / 40 mm	48 dB
23	H60 steel bulkhead restr. + thermal	SeaRox SL 660, 30 mm and SeaRox WM 660, 40 mm / 40 mm and 50 mm SeaRox SL 720	50 dB
24	H60 steel bulkhead restr. + thermal	SeaRox SL 660, 30 mm and SeaRox WM 660, 40 mm / 40 mm and 50 mm SeaRox MA 720 ALU	51 dB
25	H120 bulkhead restricted	SeaRox SL 660, 30 mm and SeaRox WM 660, 40 mm / 2 x 40 mm	49 dB
26	H60 steel deck	SeaRox SL 660, 2 x 50 mm / 2 x 50 mm	48 dB
27	A60 aluminium bulkhead	SeaRox SL 620, 2 x 30 mm / 2 x 30 mm (on both sides)	40 dB
28	A60 aluminium bulkhead	SeaRox FM 6040 ALU, 2 x 35 mm / 2 x 35 mm (on both sides)	46 dB
29	Thermal insulation	SeaRox MA 7000 ALU, 50 mm / 50 mm	45 dB
30	Acoustic insulation	SeaRox FM 6020 ALU, 90 mm (no insulation on stiffeners)	49 dB

ISO 10140-2:2010-compliant laboratory test reports are available. Contact your local ROCKWOOL Technical Insulation representative.

Thermal and comfort insulation



The requirements of indoor climate and comfort have been tightened in the recent years. Insulation is an important factor here, as it ensures the indoor environment is at the correct temperature.

The great advantage of our SeaRox products is that the high level of thermal insulation can be combined with excellent noise reduction capabilities and often fire protection constructions will also act as thermal comfort insulation.

All our SeaRox insulation products fulfil the IMO “non-combustibility” and “low fame spread” requirements. They also have excellent water-repellent properties, which is important as comfort insulation is often placed directly up against the outer construction where the temperature is subject to change.

1: Thermal insulation can be used on its own where there is no other demand for the deck and bulkhead.

2: Thermal insulation can also be used together with fire insulation or sound insulation.



NEW Lightweight thermal insulation

Following the success of our lightweight range for fire rated applications we introduce a new low weight product for thermal insulation of bulkhead, decks and outer bulkheads, SeaRox MA 7000 ALU.

The product is delivered in 26 kg/m³ as a highly compressed, compact roll and delivered as standard with reinforced aluminium on one side.

The lower weight contributes to the overall weight saving and consequently to the energy efficiency and lower costs and reduction of CO₂ emissions.

The product combines the properties of low weight, high thermal performance, excellent acoustic properties and lowest water absorption.

The low density combined with the generic stone wool characteristics secure an easy installation with high end-result.

In all cases, when insulating against cold temperatures the wool must always be covered by a vapour-tight surface. This may be aluminium foil or another kind of vapour barrier. The gaps should be tightly sealed with aluminium tape. Any additional insulation to a fire construction should be documented and approved by the local surveyor.

The most common way of expressing thermal properties is by using the following nomenclature:

- Coefficient of the Thermal Transmission (U-value)
- Thermal Resistance (R)
- Thermal Conductivity (λ)

It is important to note that the λ-value for any given material varies with temperature.

Lambda value (λ) measurements on ROCKWOOL Technical Insulation products (nominal values):

Product [W/mK]	10
SeaRox FB 6000 range	0.034
SeaRox FM 6000 range	0.034
SeaRox MA 7000 ALU	0.037
SeaRox SL 720	0.035
SeaRox SL 740	0.035
SeaRox SL 320	0.035
SeaRox SL 340	0.035
SeaRox SL 436	0.037
SeaRox SL 440	0.037
SeaRox SL 480	0.037
SeaRox SL 620	0.035
SeaRox SL 640	0.037
SeaRox LM 900	0.039
SeaRox WM 620	0.035
SeaRox WM 640	0.036
SeaRox WM 660	0.037
SeaRox SL 660	0.037

Floating floors and panels (outfitting)

Floating floors

Good noise reduction between decks is needed to create a comfortable environment. To prevent noise – particularly impact noise and structure-borne noise – travelling from one cabin to another you must use an insulation solution with the requisite rigidity, elasticity and noise reduction properties. We offer alternative solutions. One is based on SeaRox SL 436, which is widely used by dedicated floating floor companies as a core material, combined with different types of load-spreading top layers. This solution has been optimized to get the best dynamic stiffness and acoustic performance. The special design of SeaRox SL 436 results in lower compression strength compared to more rigid SeaRox slabs.

For areas subjected to higher loads, an insulation product with higher compression resistance may be needed. In such cases SeaRox SL 440 and especially SeaRox SL 480 will be more durable solutions in combination with surface steel plates.

SeaRox SL 436, SeaRox SL 440 and SeaRox SL 480 are all included in the ROCKWOOL A60 floating floor solution.

The ROCKWOOL SeaRox SL 436, 440 and 436 in densities of 140-200kg/m³, are also used by specialist flooring in more advanced floating floor systems, typically in combination with viscoelastic materials, alternative top layers etc.

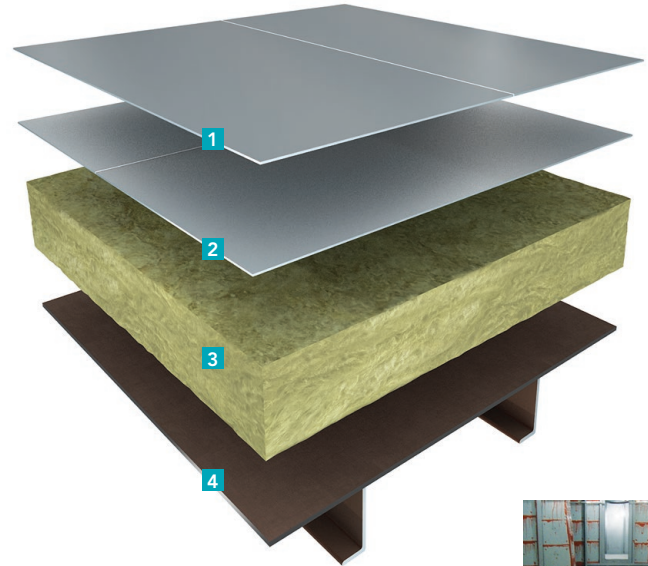

ROCKWOOL A-60 floating floor system (example)

- 1 Steel top plate 1.5 mm
- 2 Steel top plate 1.5 mm
- 3 SeaRox SL 436, SL 440 or SL 480 60 mm
- 4 Steel deck plate (Standard FTP code)

Note: 2 x 1.5 mm steel top plates to be glued together



Panels

B-Class fire restriction zones and fire protection are required between each cabin throughout the accommodation areas of a vessel or living quarters, as is noise insulation between each cabin and public areas.

The SeaRox slab range of products has a great track record here. We have worked with customers to develop a large number of special products with high compressive and delaminating strength as well as great fire resistance, which have been approved as non-combustible according to the latest IMO regulations.

This gives panel and door manufacturers an outstanding core material for the fabrication of sandwich constructions.

Technical insulation for comfort and safety onboard

Pipe insulation

Pipe insulation is rarely visible, but often decisive for comfort and safety onboard. The safety rules of SOLAS (Chapter II-2) for hot surfaces in engine rooms must be followed. Pipe insulation is also needed to reduce the surface temperature on the pipes so that people working in the vicinity are not burned if they come into contact with hot pipes. Avoiding too much heat loss from the pipes may also be demanded to prevent blockage of heavy oil pipes and cargo lines for product tankers.

We have a wide selection of marine approved solutions for pipe insulation to satisfy all these requirements, for large and small pipes. The mandrel wound ProRox pipe sections are made of stone wool and produced with WR-Tech™, an innovative water-repellent binder to mitigate the risk of corrosion under insulation. The ProRox pipe sections are available both with and without reinforced aluminium foil covering.

The ProRox pipe sections are especially suitable for ambient to very high temperatures, but can also be utilized for chilled media.

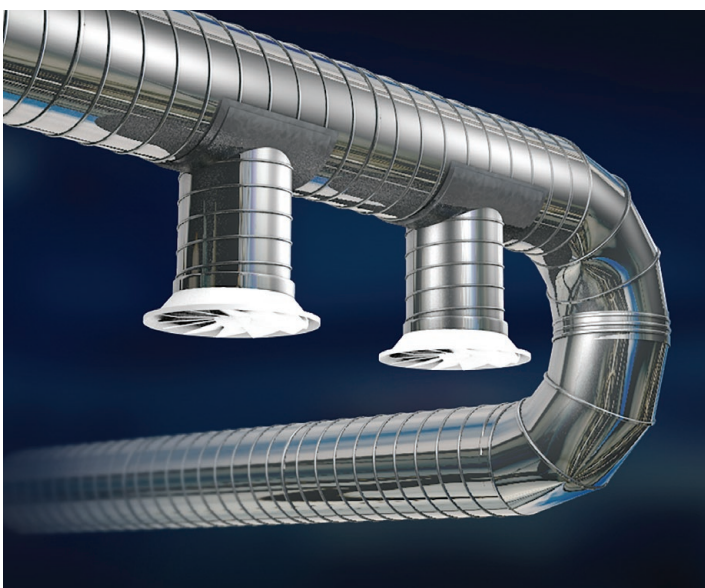

Air ducts

Today, great demands are made on air ducts. The most important challenge is safeguarding the comfort of onboard vessel or platform living quarters, without compromising fire safety standards.

When ventilating cabins and other rooms it must be ensured that no condensation is formed and that the required temperature is constantly maintained. Our SeaRox products tick all of these boxes.



Technical installations

A large range of technical equipment onboard a vessel or offshore installation must fulfil insulation requirements. This will often be a combination of thermal control, noise reduction and fire safety. At ROCKWOOL Technical Insulation we have the perfect solution, even for the most irregular sizes and shapes.

For thermal calculations of technical installations we recommend ROCKASSIST, our online calculation program.

Typical ROCKWOOL products for technical installations	Typical applications
ProRox WM 950 ProRox WM 960	Exhaust, boilers, scrubbers
SeaRox LM 900 ALU	Ventilations ducts
SeaRox FM 6040 ALU	Scrubbers
ProRox PS 960	Pipes

Products for technical installations are covered by our range of thermal insulation products.

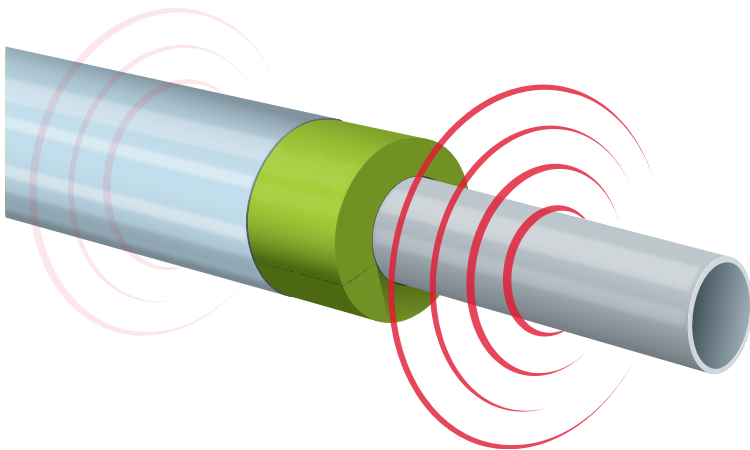

Acoustic measurements of pipes

Noise is an increasing focal point in the marine and offshore industry, also in relation to technical installations, such as pipes in and around living quarters.

ROCKWOOL Technical Insulation has tested and documented a wide range of alternative solutions fulfilling ISO 15665:2003. Similar requirements are included in NORSOK standard R-004 class 6, 7 and 8 and CINI 9.2.02.

Acoustic tests have been conducted on marine approved products in our ProRox range for their suitability as thermal insulation of technical installations (ProRox Pipe Sections and ProRox Wired Mats). They fulfilled the Class A, B and C requirements.



In general we are able to provide solutions with the following qualities:

- Excellent thermal and acoustic performance
- Easy to handle and install – thermal insulation, one heavy mass layer and metal cladding does the job
- Watertight finish possible in combination with ProRox GRP 1000

Don't let water take hold of your pipes

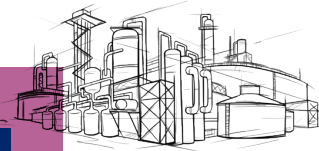

Combat the risk of corrosion under insulation

CUI is a major issue in the industry. It leads to higher maintenance costs and can cause pipe leaks or even ruptures. According to NACE*, water-leachable salt, water retention, permeability and wettability all play a major role in mitigating the risk of CUI.

Our next generation ProRox mandrel wound stone wool pipe sections with WR-Tech™ (Water Repellency Technology) get to grips with CUI. They absorb less water, dry faster, are more durable and have a very low water-leachable salt content. Minimising the risk of corrosion under insulation.

See for yourself at rti.rockwool.com



NEW

**ProRox® PS 960/970
mandrel wound
pipe sections**



**Best in class solution
to help mitigate CUI**



**PATENT
PENDING**

*National Association of Corrosion Engineers - NACE SP0198-2010 (2.1.2)



What does NACE say?

Because CUI is a product of wet metal exposure duration, the insulation system that holds the least amount of water and dries most quickly should result in the least amount of corrosion damage to equipment.*

* National Association of Corrosion Engineers - NACE SP0198-2010 (2.1.2)

Next generation mandrel wound ProRox Pipe Sections with WR-Tech™

BEST IN CLASS SOLUTION

To mitigate the risk of corrosion under insulation

CUI Risk index

Standard product - Non EN-stone wool



ProRox PS 960/970



ProRox PS 960/970 - with WR-Tech



■ Water absorption ■ Dry-out time ■ Leachable chlorides

The above is a graphic visualization of aggregated CUI contributors, actual CUI performance depends on application and local conditions on site.



ROCKWOOL Technical Insulation has developed WR-Tech, an advanced water repellency technology based on a unique binder that repels water and has a low chloride content. ROCKWOOL Group recognises innovative solutions that create value for our customers and is keen to protect them. Patents are pending for the WR-Tech technology, and we take pride in and care of our patent portfolio worldwide.

PATENT PENDING

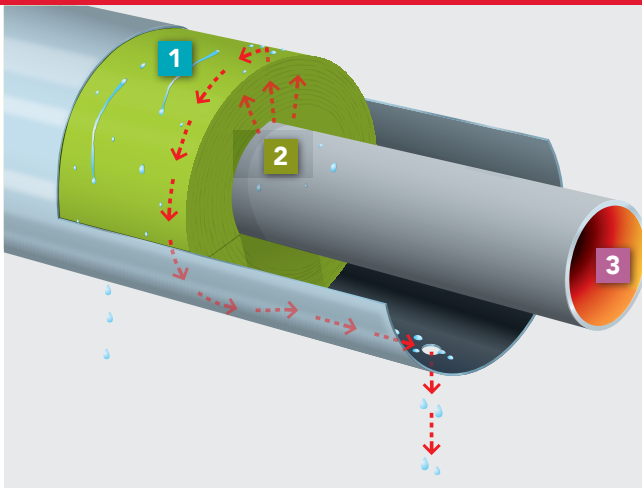

1



LOWEST WATER ABSORPTION **HIGHEST WATER-REPELLENCY**

2



QUICK RELEASE **FASTEST WATER DISSIPATION**

3



DURABLE PERFORMANCE UP TO 250°C **NO REDUCTION OF REPELLENCY**



<10PPM Cl
LOW LEACHABLE SUBSTANCES

Complies with EN 13468 & ASTM C795, the most strict standards



COATING FRIENDLY
SILICONE OIL FREE

Complies with VW test 3.10.7, does not result in fish-eyes, usable in paint shops



PRODUCT TOUGHNESS
FLEXIBLE & STRONG

No cracks when exposed to external impact

Product selector

At ROCKWOOL Technical Insulation we have developed a special range of marine products that meet the requirements of IMO's regulation in all situations. There is a ROCKWOOL SeaRox product with the required approval for virtually every construction.

The table below gives a general idea of product applications in different constructions.



	SeaRox FB 6020 / FB 6040 / FB 6050	SeaRox FM 6030 ALU	SeaRox FM 6040 ALU	SeaRox FM 6050 ALU	SeaRox MA 7000 ALU	SeaRox SL 720 / SeaRox MA 720 ALU	SeaRox SL 740	SeaRox MA 740 ALU	SeaRox SL 320	SeaRox SL 340	SeaRox SL 436	SeaRox SL 440	SeaRox SL 480	SeaRox SL 620	SeaRox SL 640	SeaRox SL 660	SeaRox WM 620	SeaRox WM 640	SeaRox WM 660	SeaRox LM 900 ALU	ProRox WM 950	ProRox PS 960	
Bulkhead and deck																							
Fire (A class divisions)	■	■	■	■							■	■	■	■	■		■	■					
Fire (H class divisions)																■				■			
Comfort insulation (Thermal)					■	■	■	■													■		
Outfitting											■	■	■										
Sound insulation									■	■													
Technical installations																							
Thermal (Pipes)	< 250°C																				■		■
	> 250°C		■																			■	■
Thermal (Tanks)	< 250°C					■	■														■		
	> 250°C		■											■								■	
Thermal (Air ducts)																					■		
Fire (A-60 pipelines)																	■						
Fire (Air ducts)													■			■							
Sound insulation (Pipes)																						■	■

Product overview

COMFORT INSULATION

Products mainly for thermal insulation of accommodations

	Product	Thickness mm	Length mm	Width mm	Application
	SeaRox MA 7000 ALU	50, 100	3000	1000	Lightweight stone wool mat for thermal insulation for bulkhead and decks. Delivered with reinforced aluminium on one side, as a highly compressed, compact roll.
	SeaRox SL 720	50, 100	1000	600	Low weight and semi-rigid slab for comfort insulation. Can be delivered with reinforced aluminium on one side.
	SeaRox SL 720 ALU	50			
	SeaRox MA 720 ALU	50, 100	4000	1000	Low weight and highly compressed roll used for comfort insulation. Delivered with reinforced aluminium on one side.
	SeaRox SL 740	25-100	1000	600	Low weight and semi-rigid slab for comfort insulation. Can be delivered with reinforced aluminium or white glass cloth on one side.
	SeaRox SL 740 ALU				
	SeaRox SL 740 GW 200				
	SeaRox MA 740 ALU	50	3000	1000	Semi-rigid compressed roll used for comfort insulation. Delivered with reinforced aluminium on one side.

ACOUSTIC INSULATION

Products mainly for sound absorption

	Product	Thickness mm	Length mm	Width mm	Application
	SeaRox SL 320	50, 75	1000	600	Semi-rigid slab primarily used for sound insulation.
	SeaRox SL 340	50	1000	600	Semi-rigid slab primarily used for sound insulation. Can be delivered with reinforced aluminium or black tissue on one side.
	SeaRox SL 340 ALU				
	SeaRox SL 340 TB				
	SeaRox Acoustic Foil			1000	Thin, strong and durable film for mainly engine rooms to maintain the high noise absorption properties of the ROCKWOOL material.

OUTFITTING INSULATION





Products mainly as components of systems

	Product	Thickness mm	Length mm	Width mm	Application
	SeaRox SL 436	30, 40, 50, 60	1000	600	Rigid slab for insulation of floating floors only. Approved for A-60 floating floors.
	SeaRox SL 440	50, 100	1000	600	Strong and rigid slabs for floating floors or to be cut into lamellas and used for panels.
	SeaRox SL 480	30, 50	1000	600	Strong and rigid slabs for floating decks or to be cut into lamellas and used for panels. Approved for A-60 floating floors.

Local variations in products and dimensions might occur.

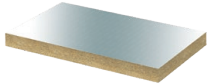
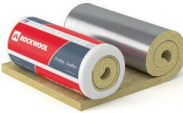
FIRE-SAFE INSULATION

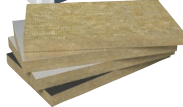
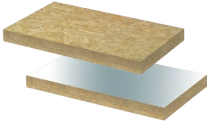
Products mainly for fire rated constructions

	Product	Thickness mm	Length mm	Width mm	Application
	SeaRox FB 6020	70	1000	600	New generation SeaRox fire boards. Lightweight stone wool solutions for A-class constructions. Can be delivered with reinforced aluminium or glass cloth on one side.
	SeaRox FB 6040	35, 70			
	SeaRox FB 6050	30, 75			
	SeaRox FB 6020 ALU	70	1000	600	New generation SeaRox fire boards. Lightweight stone wool solutions for A-class constructions. It is delivered as standard with reinforced aluminium on one side.
	SeaRox FB 6040 ALU	35, 70			
	SeaRox FB 6050 ALU	30			
	SeaRox FM 6030 ALU	30	3200	1000	New generation SeaRox fire mats. Lightweight stone wool solutions for A-class constructions. Delivered as standard with reinforced aluminium on one side.
	SeaRox FM 6040 ALU	35, 50, 80, 100	3500 - 6000	1000	New generation SeaRox fire mats. Lightweight stone wool solutions for A-class constructions. Delivered as standard with reinforced aluminium on one side.
	SeaRox FM 6050 ALU	75	2800	1000	New generation SeaRox fire mats. Lightweight stone wool solutions mainly used for 4 mm aluminium, A-class constructions. Delivered as standard with reinforced aluminium on one side.
	SeaRox SL 620	25-75	1000	600	Rigid slab for fire insulation in A-class constructions. Can be delivered with reinforced aluminium or white glass cloth on one side.
	SeaRox SL 620 ALU	25-75			
	SeaRox SL 620 GW 200	25-75			
	SeaRox SL 640	30, 40, 50	1000	600	Rigid slab for fire insulation in A-class constructions. Can be delivered with reinforced aluminium or white glass cloth on one side.
	SeaRox SL 640 ALU	30, 40, 50			
	SeaRox SL 640 GW 200	30, 40, 50			
	SeaRox SL 660	30, 50	1000	600	Special product used for insulation of H-class constructions. Can be delivered with reinforced aluminium on one side.
	SeaRox SL 660 ALU				
	SeaRox WM 620	45	4000	1000	Flexible Mat, one side faced with wire netting. Used for A-class constructions and penetrations. Can be delivered with reinforced aluminium on one side.
	SeaRox WM 620 ALU				
	SeaRox WM 640	30, 50, 75	2-7000	1000	Flexible Mat, one side faced with wire netting. Used for A-class constructions and penetrations. Can be delivered with reinforced aluminium on one side.
	SeaRox WM 640 ALU				

TECHNICAL INSULATION

Products mainly for thermal insulation of technical installations

Product	Thickness mm	Length mm	Width mm	Application
 <p>SeaRox WM 660 SeaRox WM 660 ALU</p>	40	4000	500	Flexible mat, one side faced with wire netting. Special product used for insulation of H-constructions. Can be delivered with reinforced aluminium on one side.
<p>ProRox WM 950 ProRox WM 950 ALU</p>	50, 80 50, 80	2-4000	1000	Flexible mat, one side faced with wire netting. Used for technical installations mainly pipes. Can be delivered with reinforced aluminium on one side.
 <p>SeaRox LM 900 ALU</p>	30	8000	1000	Lamellas placed edgewise on reinforced aluminium (roll). For insulation of pipes, tanks and ventilation ducts.
 <p>ProRox PS 960 with WR-Tech ProRox PS 960 ALU with WR-Tech</p>	20-100	1000	17-356	New generation ProRox mandrel wound pipe sections with WR-Tech (Water Repellency Technology). Rigid Pipe Sections for steam and process pipes. Can be delivered with reinforced aluminium and self adhesive tape.

Local variations in products and dimensions might occur

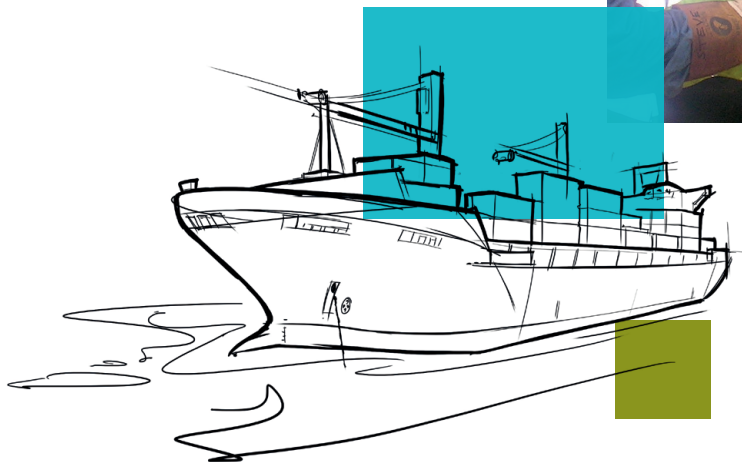

ROCKWOOL Technical Insulation

ROCKWOOL Technical Insulation, is part of the ROCKWOOL Group, and is offering advanced technical insulation solutions for the process industry as well as the marine & offshore.

At the ROCKWOOL Group, we are committed to enriching the lives of everyone who experiences our product solutions. Our expertise is perfectly suited to tackle many of today's biggest sustainability and development challenges, from energy consumption and noise pollution to fire resilience, water scarcity and flooding. Our product range reflects the diversity of the world's needs, while supporting our stakeholders in reducing their own carbon footprint.

Stone wool is a versatile material and forms the basis of all our businesses. With approximately 11,000 passionate colleagues in 39 countries, we are the world leader in stone wool solutions, from building insulation to acoustic ceilings, external cladding systems to horticultural solutions, engineered fibres for industrial use to insulation for the process industry and marine & offshore.

All explanations correspond to our current range of knowledge and are therefore up-to-date. The examples of use outlined in this document serve only to provide a better description and do not take special circumstances of specific cases into account. ROCKWOOL Technical Insulation places great value upon continuous development of products, to the extent that we too continuously work to improve our products without prior notice. We therefore recommend that you use the most recent edition of our publications, as our wealth of experience and knowledge is always growing. Should you require related information for your specific application or have any technical queries, please contact our sales department or visit our website rti.rockwool.com

Check rti.rockwool.com
for latest update



ROCKWOOL Technical Insulation

ROCKWOOL BV
Delfstoffenweg 2
6045 JH Roermond
Netherlands
Tel. +31 (0) 475 35 36 18
Fax +31 (0) 475 35 36 01
E-mail: rti.export@rockwool.com
rti.rockwool.com

ROCKWOOL Technical Insulation
is part of ROCKWOOL A/S



ROCKWOOL® Technical Insulation, ROCKWOOL®, SeaRox® and ProRox® are registered trademarks of ROCKWOOL A/S and cannot be used without a prior written consent. ROCKWOOL Technical Insulation reserves the right to change the information in this brochure without prior notice.